

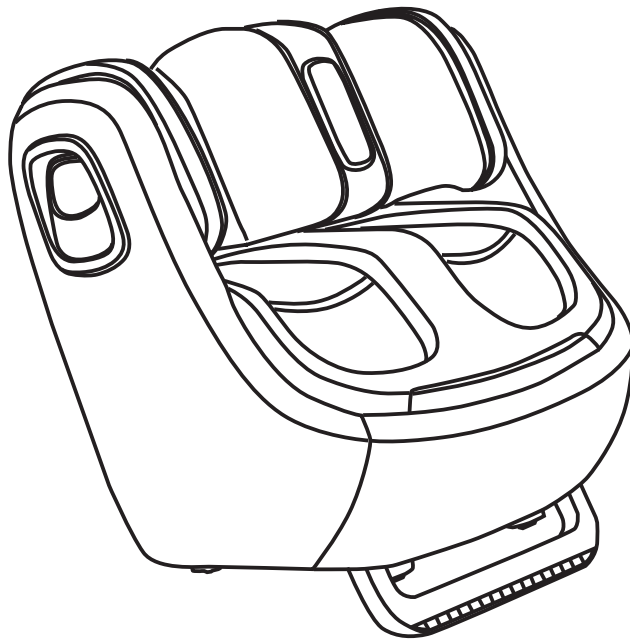

OmKNEE

total foot reflexology **PLUS**



User Manual
OF 2003 使用手册





OGAWA

OmKNEE
total foot reflexology **PLUS**

User Manual

All information is correct at the time of print

1



CONTENTS

Safety Instructions	03
Warranty Claims	06
Product Parts	07
Product Features And Operation Illustrations	08
Product Operation Guide	09
Product Maintenance	13
Troubleshooting	14
Product Specifications	15
Contact Us	16



Thank you for purchasing OGAWA OmKnee Plus leg massager. Please read the Safety Precautions carefully before using the leg massager. The Safety Precautions are divided into 'warnings' and 'attention' in terms of the degree of danger. This book should be kept available for future reference after reading.





Safety Instructions

a) Important safety instructions

- To ensure a safe and proper operation, please read the instruction manual carefully before using this product.
- Use this product only as described in this manual.
- Always unplug this product from the electrical outlet immediately after use and before cleaning.
- Do not use this product if you have sensitive skin, neuropathy or poor circulation. Don't let children or people with mental disabilities use the heating function without proper supervision. Improper use may be dangerous.
- Do not operate this product under a blanket or when covered. Over-heating can occur and cause fire, electric shock or injury.
- Do not cover this product in order to avoid electrical faults or damages due to excessively high motor temperature.
- Stop the massage immediately if you feel any discomfort.
- Never operate this product if it has been dropped, has a damaged cord or plug; experiences a malfunction, or if it has been dropped in water. Please contact an authorized service centre to do the necessary check and repair.
- Do not use the components that are not recommended by OGAWA.
- Do not insert any objects into any openings in the product.
- If you want to cut off the power supply, please make sure you have turned off all the operating controls, as well as remove the power plug from the socket.
- Please do not use this product as a medical device. If you need a professional diagnosis or treatment, please consult a professional medical person.

b) Operating Environment Precautions

- Do not use this massager in humid or extremely dusty environments to avoid malfunction.
- Do not use this massager at a temperature above 40 degree centigrade.
- Do not use this massager outdoors.
- Avoid placing or operating this massager in direct sunlight or near a heating appliance, stove.



Safety Instructions

c) User precautions

- Make sure that this product is far away from any hot surfaces.
- Please consult your doctor before use for those who have the following diseases:
 - Those who have heart disease, malignant tumor, back pain, spinal scoliosis, hypertension, osteoporosis, etc.
 - Those who are pregnant or having a menstrual period.
 - Those who have a physical discomfort, fever, a swelling or inflammation, bruises, allergies, etc.
 - Those who are warned by the doctor not to do any massage to avoid injury or physical discomforts such as blood clots (thrombosis), severe aneurysm, acute venous tumor, all kinds of skin inflammation, infectious skin disease (including subcutaneous tissue inflammation), etc.
 - Warnings: Do not use the massager together with the following medical instruments.
 - 1) Those who are using a pacemaker or other implantable medical equipment.
 - 2) Those who are using an artificial heart.
 - 3) Those who are wearing an electrocardiograph for similar medical equipment.

Otherwise it will cause malfunction for those medical equipment, putting the user's life in danger.

d) Precautions for power supply

- Do not turn on the switch when your hands are wet.
- Do not immerse in or spray water or liquid on the control power switch.

e) Cord/Plug Precautions

- Do not connect or remove the plug with wet hands. Otherwise you will suffer an electric shock or a product malfunction.
- Do not pull the wires when you pull out the power plug. Please hold the plug itself.
- As the default operating time is 15 minutes, all the functions will stop working after 15 minutes. Please unplug this product from the electrical outlet immediately after use.
- Keep the cord away from hot surfaces.
- Do not place the power plug under the product or any heavy items.







Safety Instructions

- Do not wind the power plug around the product lest it should be damaged and cause an electric shock or fire.
- Do not operate this product if it has a damaged cord or plug.
- Do not use this product if the power socket is loose.
- Do not carry this product by its supply cord or use the cord as a handle.
- When the power plug is damaged, please call the service centre or an authorized technical person for the necessary check and maintenance.

Attention

- 
- 
- Do not fall asleep while massager is on.
 - Do not use this product while you are drunk or physically uncomfortable.
 - Don't stand on the product or put a heavy weight on it.
 - Do not use this product for more than 30 minutes.
 - Do not use this product if the cloth cover is worn out.
 - Do not use this product within an hour before or after a meal.
 - When you are using the rollover function, when the flip angle has reached its maximum, please do not continue to flip hard, or it may damage the product.
 - When you are using the product at a low room temperature, do not suddenly use the heat function. You can adjust the room temperature to normal room temperature, before starting the heat function.
 - When moving this product from a low temperature storage place to a warmer setting, it may cause malfunction due to water vapor gathered in the components. Set the product in a normal room temperature for one hour before using it.
 - Do not use this product continuously if you find any components damaged or the product in an abnormal condition.
 - When current interruption occurs during your massage, try to avoid further damage due to sudden power restoration.
 - Stop using the product if there is thunder and lightning.



Warranty Claims

1. Warranty is not transferable.
2. This warranty is effective only if the product is purchased from OGAWA.
3. Proof of purchase (original receipt) is required for all warranty repairs.
4. All implied warranties, including but not limited to these implied warranties of fitness and merchantability, are limited to the duration stated in the warranty policy.
5. Damage due to misuse, improper treatment and unauthorized modification and repair are not covered by this warranty.
6. Warranty does not cover accessories and attachments which do not belong to the massage unit.
7. Warranty is not effective to rental, business, commercial, institutional or other non-residential users.
8. All services covered by this warranty must be approved by OGAWA and repaired by authorized technicians only.
9. If replacement parts for defective materials are not available, OGAWA reserves the right to make substitution in lieu of repair or replacement.





Product Parts

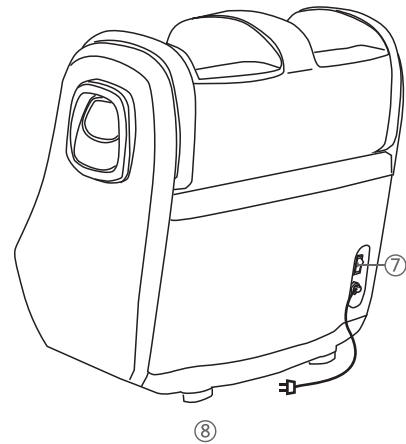
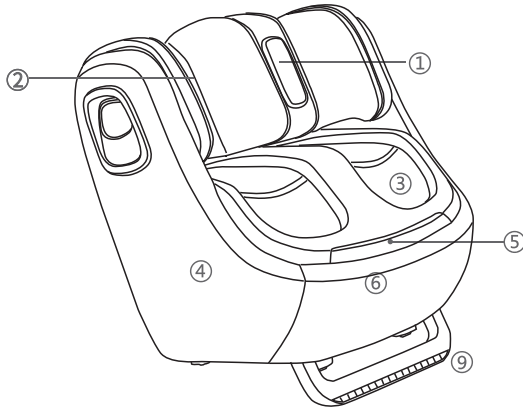

- ① Touch screen panel
- ② Rollover-style leg massage area
- ③ Detachable fabric cover
- ④ Side cover
- ⑤ Decorative plate
- ⑥ Feet massage area
- ⑦ Power switch
- ⑧ Four sets of transportation wheels on the ground
- ⑨ Stand

Product Features And Operation Illustrations

- Specially designed for knee care; U-style wrapped air compressing massage with a comfortable warm heating function, to help relieve knee pains and discomfort.
- Rotate it as you wish, – this is the first developed innovative rotation structure with 225° rotation space/11 adjustment levels, enabling you to enjoy it freely.
- New programmes: Tone/Revive/OmKNEE/Reflexology programmes are designed for different groups, to protect your legs, relieve your pressure, and ease your body and mind.





Product operation illustrations

Leg part

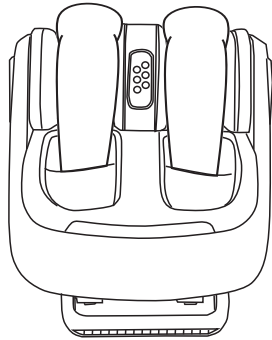

Knee part

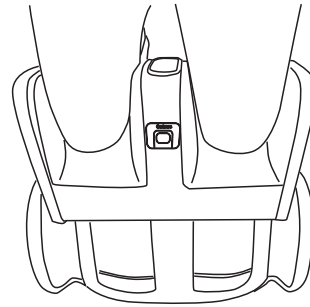

Remarks: If you would like to adjust a different angle in the process of massage, please make sure you have first turned off all the functions, before moving out your legs and then doing the necessary adjustment.



as shown on picture3, there is a square sponge pad on each side of knee massage position, which can be taken out from the shown position. According to individual needs, if massage strength is weak, the sponge pad can be removed.

Massage diagram 3

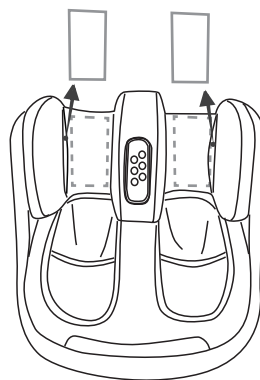

Product Operation Guide

Illustration for touch screen control panel

Leg part



Knee part

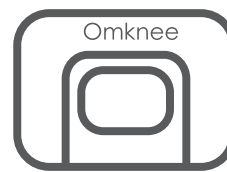

① Power Keys Power

Turn the power supply on, the green light will start to blink; press the power key. The blue light is on, all the other key functions will start to work.

Press again, power off.

The automatic program is 15 minutes. 1 minutes before finish massage, di di di lasts three times. Di di di once again when massage finished.

② Heat Heat

In standby mode, when enabled, heating function is on effect, the blue indicator light is on, press again, Heating function is off.

In automatic program mode, heating function is on effect, press again, Heating function is off.



③ Foot Keys

Foot

In standby mode, press once, enable the foot massage with the blue indicate light on. Press again to turn it off.

④ Legs Keys

Legs

In standby mode, press once, enable the leg massage with the blue indicate light on. Press again to turn it off.

⑤ Mode Keys

Mode

In standby mode,
Press to select massage program
Revive : Green
Tone : Blue
Reflexology : Red

⑥ Intensity Keys

Intensity

Control the intensity of the massage. When the product starts working, we can adjust the intensity accordingly (the default level is medium)
Intensity illustration: Green : weak ; Blue : medium ; Red : strong.

Product Operation Guide

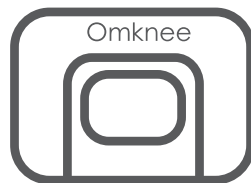

① Omiknee Keys

In standby mode, press once to enable Omiknee function. During the massage, heating function will take effect automatically. The heating effect is controlled separately, press once to close heating, press this key twice to finish the massage.



Product Operation Guide

a) Instructions before use

Please store this product in a dry place, do not expose the product to direct sunlight. Put the carpet under the product to minimize the working noise.

b) How to use it

This product uses only the AC 220V-240V, 50/60Hz power supply.

Make sure your indoor voltage fits this specification parameter.

- Connect the AC power cord to the socket.
- Turn on the power switch at the back of product to "I", when the red light is on, the yellow light on control panel blinks, the product is in standby mode.

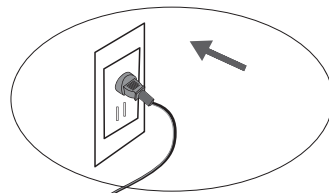

Do not insert or remove the plug with a wet hand

Before plugging in the socket, make sure turn the main power switch to "0" 

- Choose your desired massage area to begin the massage.

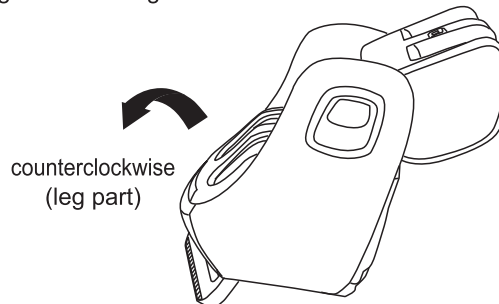
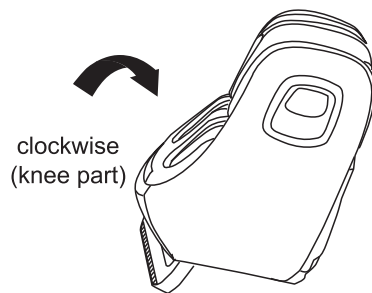

(Remarks: Product roll over angle is limited of adjustment, and a 125 degree rotation. Once it reaches the peak point, please turn it gently and continuously, to avoid product damage.)



Product Operation Guide

- Place your legs in the product, before pressing the switch key on screen. When the blue light is on, the other functions will follow. According to the indicators on the control panel, you can choose different massage modes.
- When you start the massage, the product will be countdown in 15minutes. After 15 minutes, the massage function is turned off, and it will recover to standby mode.
- When the product is on standby, press the main switch "0" to cut off the power.
- Transportation wheels

There are transportation wheels installed at the base of the product. This is for moving and storage. Please hold the two sides of the product tightly, before moving the product around.



Product Maintenance

a) Storage

- Please store it in the packing carton, and put in a safe, dry, well-ventilated, and shaded place.
- Do not twist the power plug.
- Do not hang the power wire and pull the product.
- Avoid sharp items from destroying the surface of the product.
- Please don't store the machine under direct sunlight or in places of high temperature.

b) Clean

- Before cleaning, make sure that the power cord is unplugged from the electrical outlet and that the machine is completely cool.
- Use a damp cloth to clean the product. Ensure the product is completely dry before reuse.
- The detachable fabric cloth can be washed in a normal washing way.

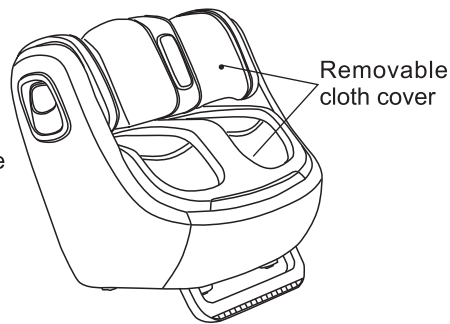

*Attention

- Make sure not to use benzene or thinner and other corrosive detergents to clean the product.

c) Maintenance

- Keep the product clean and store in a dry environment.
- When the product is not in use for a long time, please put a dustproof cover on the product.

Troubleshooting

If you meet the following problems, please referring to the following solutions. If the product is still malfunctioning or doesn't work, please send the product to our service centre or an authorized technician for the necessary checks and repair.

Conditions	Possible reason	Solutions
It doesn't work	<ol style="list-style-type: none">1. Plug isn't connected correctly to the socket.2. The power switch at the back is off.3. Switch key on control panel isn't on.4. The fuse blows out.	<ol style="list-style-type: none">1. Push the plug firmly into the socket.2. Switch on the power switch at the back of the product.3. Switch on the on/off key on the panel.4. Insert a tooth pick in the small hole of "fuse" under the switch power, before taking out the fuse.
Stop working suddenly	<ol style="list-style-type: none">1. The power switch is off.2. Massage time is over 15 minutes.3. If it is working for a long time, the motor will be protected against overheating.4. If you put heavy pressure on the rollers and the rollers do not work well.	<ol style="list-style-type: none">1. Check that the power plug is connected well.2. Restart the power supply switch.3. After the product is cooled down, please restart the ON/OFF power.4. Switch off the power supply, and turn it on again.



Product Specifications

Product name	OmKNEE Plus
Model number of the product	OF 2003
Voltage	AC 220V-240V, 50/60Hz
Power consumption	105W
Timer	15 minutes



Contact Us



MALAYSIA
Healthy World Lifestyle Sdn Bhd
No. 22 Jalan Anggerik Mokara 31/47
Kota Kemuning, 40460 Shah Alam
Selangor Darul Ehsan, Malaysia
Tel : +603-5121 4286
Fax: +603-5121 4386



HONG KONG, CHINA
OGAWA Health Care International(HK) Ltd
31/F, YHC tower, 1 Sheung Yuet Road
Kowloon Bay
Kowloon
Hong Kong
Tel: +852 3465 6262
Fax: +852 2410 0119



SINGAPORE
OGAWA Health-Care Pte Ltd
27/Tampines Industrial Avenue 5,
T5@Tampines
Singapore 528623
Tel: +065-6846 8588
Fax: +065-6846 7677



VIETNAM
OGAWA Vietnam Co Ltd
2nd floor, Petroland Tower,
12 Tan Trao, Tan Phu ward
District 7
Ho Chi Minh
Tel: +848 54133 222/54133 223
Fax: +848 5416 1736



INDONESIA
PT Healthy World
Lodan Center Block O No 20
Jalan Lodan Raya No 2
Jakarta Utara 14430
Tel : +62 21-6983 1123
Fax: +62 21-6983 1124





PHILIPPINES
O-Healthcare Solution Phil. Inc.
2303, 4th Floor, G&A Building,
Chino Roces Avenue Extension,
Makati City, Philippines
Tel : +632 889 0676 / +632 844 6851
Fax: +632 812 0421



目录

安全说明	18
保修权限	21
产品部件	22
产品特性及使用示意	23
产品操作说明	24
产品保养	28
疑难解答	29
产品规格	30
联络我们	31



感谢您购买 OGAWA Omknee Plus 翻转式护腿机，使用前请仔细阅读操作手册，并特别注意安全事项，以便正确操作和使用本产品。
本手册提供使用者安全及有效的操作方式，请在阅毕后妥为收藏，以便日后参考查询。

安全说明

a) 重要安全事项说明

- 为确保安全及正确使用产品，使用前请务必详细参阅操作手册。
- 请务必依照本操作手册内的产品用途使用本产品。
- 使用完毕后或清洁产品前，请将电源插头从插座中拔除。
- 请务必谨慎使用温热功能，以避免可能会导致严重灼伤。请勿用于感觉迟钝和过于敏感的皮肤或血液循环不良的部位。切勿让儿童或者身心功能障碍者自行使用温热功能，操作不当可能存在危险。
- 为避免因过热而导致走火、触电、或造成伤害，请勿将产品置于枕头或毯子下操作。
- 请勿覆盖使用，以免造成马达温度过高而导致故障或损坏。
- 如在按摩进行中感到不适，请立即停止按摩。
- 下列状况发生时，切勿使用本产品：电源线或电源插头损坏；操作不正常；曾倾倒或者损伤；曾浸入水中或其他液体。请联系维修服务中心进行检查和维修。
- 请勿使用非OGAWA所推荐的零配件。
- 请勿将物品插入或者掉落产品的任何开口中。
- 若想切断电源，请将所有的操作控制关闭后，将电源插头从插座中拔除。
- 本产品不能作为自我诊断或治疗之用，如需要诊断或治疗，应由专业医疗人员处理。

b) 使用环境

- 请勿在潮湿或过多灰尘的环境下使用产品，以免产品发生故障。
- 请勿在室温高于40° C的环境下使用本产品。
- 请勿将产品放置户外。
- 请勿将产品放置于电热器、炉具附近或者阳光直射处。

安全说明

c) 操作安全

- 确保本产品远离发热表面及区域。
- 此产品不适宜以下人士使用：
 - 心脏病患者、恶性肿瘤患者、背痛、脊椎侧弯或异常、高血压、骨质疏松症等。
 - 孕妇或经期女性。
 - 身体不适者，发烧、身体有红肿或发炎、瘀青、过敏等。
 - 医生叮嘱禁止按摩的人请勿使用，以免导致事故或身体不适如血栓（栓塞）病症；重度动脉瘤；急性静脉瘤；各种皮炎；皮肤感染病症（含皮下组织炎症）等。
 - 绝对不能与以下医疗电子仪器一起使用
 - 1) 心脏起搏器等植入式医疗电子仪器。
 - 2) 人工心脏等用来维持生命的医疗电子仪器。
 - 3) 心电图机等佩戴式医疗电子仪器。

否则可能会导致上述医疗电子仪器产生误动作，可能会危及生命。

d) 开关注意事项

- 请勿用湿手操作控制开关。
- 请勿让控制开关接触水等液体。



e) 使用电源插头及电源线须知

- 请勿用潮湿的双手安插或者拔除电源插头，以免触电或者导致机件故障。
- 拔出电源插头时，请握住插头本身，切勿拉扯电线。
- 虽然15分钟自动定时功能会自动停止产品运作，仍请每次使用完毕后，务必将主电源切断。
- 电源线务必与加热表面保持安全距离。
- 请勿将电源线置于产品或任何重物之下。
- 请勿将电源线缠绕于产品上，以免电源线受损而导致触电或者电线走火。
- 当电源线或者电源插头损坏时，切勿继续使用产品。
- 电源插座有松动的状况时，请勿使用产品。
- 请勿以拉扯电源线方式移动产品，或将电源线当握把使用。
- 当电源线损坏时，必须由服务中心或经授权技术人员进行检查及维修。



安全说明

注意

- 请勿在产品操作时入睡。
 - 请勿在酒醉或身体不适时使用本产品。
 - 请勿站在产品上或重物施压。
 - 连续使用本产品时间请勿超过三十分钟。
 - 若产品的布套已经破损，请勿使用。
 - 请勿在进食前后一小时使用，以免造成反效果。
 - 使用产品翻转功能时，如翻转角度已达最大时，请勿继续用力翻转，否则有可能导致产品损坏。
 - 在偏低室温中使用产品时，切勿骤然使用温热功能，建议将温度逐渐调至正常范围后再使用。
 - 若是将产品由低温储存处移至温暖环境使用时，可能会因为机件内水汽聚集而影响产品正常运作，甚至造成机件故障。建议移动后，先将产品在正常室温放置1小时后再开始使用。
 - 使用中察觉任何机件故障或不正常状况，请立即停止使用。
 - 若在使用中发生电流中断的状况，因注意避免因电力突然恢复而造成使用者受伤。
 - 雷电情形发生时，不宜使用本产品。
- 
- 



保修权限

1. 本保修权限不可转让。
2. 本保修服务仅对在 OGAWA 购买的产品有效。
3. 当要求保修服务时，请出示购买证明（正本收据）。
4. 所有保修项目，包括但不限于这些健身及适销性的保修项目有效期限需视保修政策而定。
5. 因错误使用、处理不当以及未经授权私自改装和维修产品而导致的损坏，不属于保修范围。
6. 此保修范围不包括不属于产品本身的附件。
7. 此保修范围不适用于租赁、交易、商业、机构或其他非住宅用户。
8. 此保修范围内所涉及的维修服务需经过 OGAWA 授权，且必须由授权的技术人员维修。
9. 若需更换的维修附件缺货，OGAWA 有权采用替代配件进行维修。

产品部件

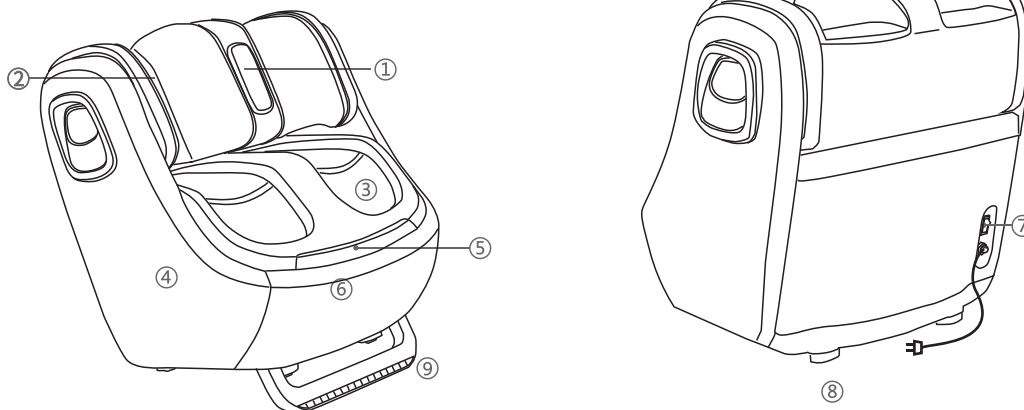

- ① 触控式控制面板
- ② 可翻转式腿部按摩区域
- ③ 可拆洗布套
- ④ 侧盖
- ⑤ 装饰电镀条
- ⑥ 足部按摩区域
- ⑦ 总电源开关
- ⑧ 底部四组移动轮组
- ⑨ 支架

产品特性及使用示意

1. 享受热敷

*分别在膝腿部和足部配置远红外加热功能，开启加热按键，膝腿部和足部同时加热。可迅速升温至45℃左右。

*加大包覆面积，舒适的温热可扩张静脉及微血管的收缩，进一步帮助循环和缓解僵硬紧绷的肌肉。

*具有扩张血管、改善局部血液循环、促进局部代谢的作用，也可缓解肌肉痉挛、松弛神经、改善筋膜柔软度。

2. 腿部按摩益处

*长期坚持腿部按摩、可加快下肢静脉回流，增加回心血量；缓解压力，可瘦小腿，于小腿肚说拜拜；



3.脚背气压的好处

- *脚背气压按摩，促进各反射区，增进血液循环，舒筋活血；使其双脚彻底放松；
- *向下顶压，让脚掌更贴合按摩头，在享受揉顶、刮痧时更舒适到位；

4.气压按摩

- *8组气袋，提供愉悦刺激感，缓和肌肉紧绷酸痛感，为您疲惫双腿代理立即舒缓。
- *脚跟后部及退后跟部增加凸点按摩；更精确刺激按摩点，让按摩更舒适；赶走疲劳；
- *气压按摩同事有效固定足部，让滚揉，刮痧和揉顶的效果更佳到位，深入。

5.脚底按摩

- *脚底三组揉捏按摩头，犹如专业脚底按摩技法，反射区滚轮按摩专门刺激足底重要穴位。
- *三组各不同按摩凸点，带来不同的按摩感受，享受搓揉、刮顶、滚揉的按摩效果；
- *定点按摩，准确按摩涌泉穴，按摩更深入。

产品使用示意

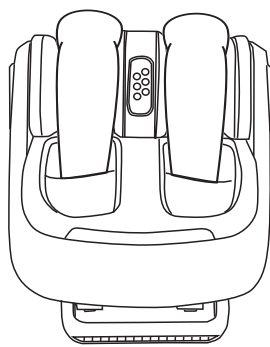

腿部

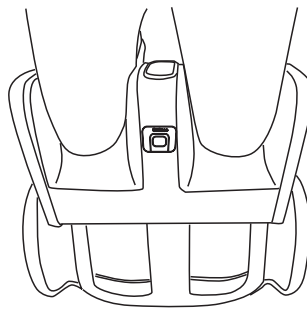

膝部

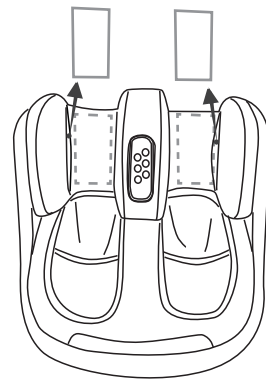

按摩示意图3

按摩示意图3

如图3所示，膝盖左右按摩的位置各有一个方形的海绵垫，从如图所示的位置取出，根据个人按摩力度需求，如果按摩膝盖时感觉力度小，可以取下膝盖左右位置的海绵垫。

注：产品使用过程中，如需翻转调节产品，请先关闭所有功能，移出双腿，再进行调整



产品操作说明

触控式控制面板说明

腿部

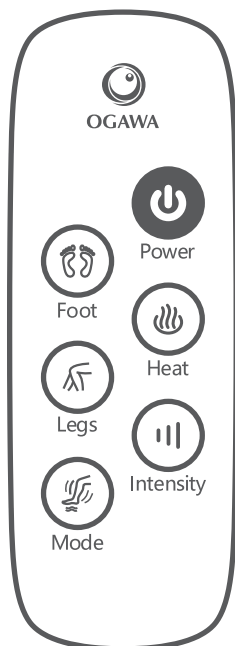

膝部

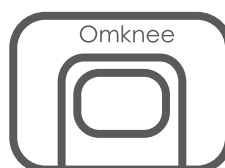

① 开关键

通电绿灯闪烁，轻触进入待机状态（显示蓝灯）。再次轻触关键。

自动程序为15分钟，结束前1分钟，滴滴滴三声提示响起，结束按摩后滴滴滴---响起。

② Heat

待机状态下轻触开启**热敷**功能，显示蓝灯，在次轻触关闭**热敷**。

开启自动程序同时启动**热敷**功能，再次轻触关闭**热敷**功能。

产品操作说明

③ Foot

待机状态下轻触开启**足部**功能（显示蓝灯），再次轻触关闭此功能。

④ Legs

待机状态下轻触开启**腿部**功能（显示蓝灯），再次轻触关闭此功能。

⑤ Mode

待机状态下轻触开启**舒活**功能（显示绿灯），
轻触2次开启**纤腿**功能（显示蓝灯），
轻触3次开启**健足**功能（显示红灯）。

⑥ Intensity

按摩过程中默认中档力度，轻触 **Intensity**调节力度（绿灯/弱 蓝灯/中 红灯/强）



⑥ Omknee

待机状态下轻触开启**护膝**功能（显示蓝灯），
按摩过程中同时打开热敷功能，如需关闭热敷，长按此键2秒
再次轻按，结束护膝按摩

产品操作说明

a) 使用前准备

请将本产品置于干燥、阳光不能长期照射的地方。
为减少机器工作时的噪音，可在本产品下铺上地毯。
确保产品放置位置安稳舒适。

b) 使用方法

本产品仅使用于AC 220伏特 - 240伏特，50/60赫的电源。请事先检查您家中电压是否与本产品上所示规格相符。

- 将交流电源插头接至电源插座。
- 启动产品背部总电源开关，按下开关上的“1”时，红灯指示，此时控制面板上开关黄灯闪烁，产品进入待机状态。

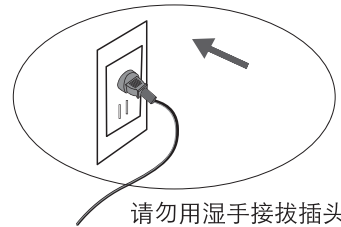

在电源插头插入之前，先确认总电源开关处于“0”  关的位置

- 依个人喜好，选择调整按摩区域。

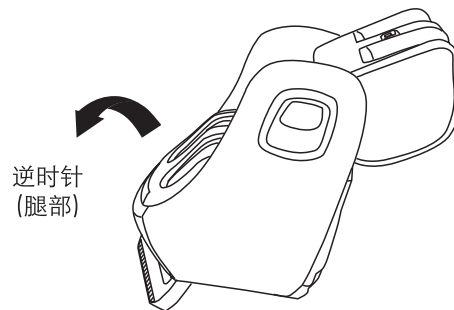
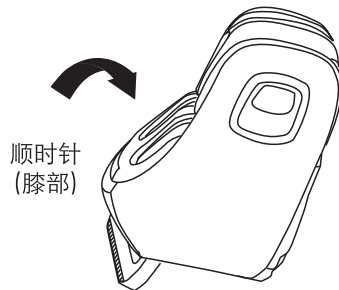

(注:产品翻转角度只限125度翻转，至最顶端时，请勿继续用力翻转，否则有可能导致产品损坏)



产品操作说明

- 将双脚放入产品，按下控制面板开关键，蓝灯指示其它按键功能响应。依控制面板指示，选择按摩模式。
- 使用产品倒计时15分钟结束后，按摩功能停止，恢复待机状态。
- 产品处于待机状态时，按下总电源开关“0”，电源切断。
- 移动轮组

本机底部设有移动轮组方便产品移动与收藏，使用时将手握住机身两侧，稍用力推进，便可移动产品。



产品保养

a) 贮藏

- 不使用时，请将产品放入包装盒中，并放置于安全、干燥、通风阳刚、阴凉处。
- 切勿扭曲电源线。
- 切勿使用电源线拖拽产品。
- 避免尖状物刮破产品表面。
- 请勿将产品放置在阳光直射或高温处。

b) 清洁

- 清洁之前，确认总电源开关已关闭，并拔出电源插头。
- 请使用干布清洁产品表面。
- 可拆洗布套可按正常布料洗涤方式清洗。

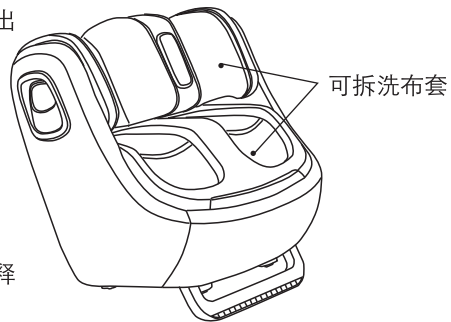

*注意

- 切勿使用具有腐蚀性的清洁剂，如苯或稀释剂来清洁产品。

c) 保养

- 保持产品清洁并远离高湿度的场所。
- 如果长时间不使用本产品，请用防尘罩(请自行购买)套住产品，防止落入灰尘。



疑难解答

若在使用此产品时遇到问题，请参考下列几点提示及可能解决方式。若此产品仍处于故障状态请将产品送至服务中心或经授权技术人员进行检查及维修。

故障	原因	处理方法
无法开机。	<ol style="list-style-type: none">1. 未通电。2. 产品背后总电源开关未开启。3. 面板开关键未开启。4. 保险丝烧毁。	<ol style="list-style-type: none">1. 接入电源或检查电源是否连接良好。2. 开启背后总电源开关。3. 开启面板开关键。4. 用类似“牙签”大小的物体插入背部总电源开关底下标有“FUSE”上方的小孔弹出保险丝，将备用的保险丝放上。
突然停止操作。	<ol style="list-style-type: none">1. 断电。2. 按摩时间超过15分钟。3. 连续使用时间过长，产品过热保护。4. 施力过大，按摩球堵转。	<ol style="list-style-type: none">1. 检查电源接口是否接好。2. 重新开启起开关键。3. 产品冷却后重新开启开关键。4. 重新启动开关键。

产品规格

产品名称	OmKNEE Plus
产品型号	OF 2003
电压	AC 220 伏特 - 240 伏特, 50/60 赫
功率	105 瓦特
定时	15 分钟

联络我们



马来西亚

Healthy World Lifestyle Sdn Bhd
No. 22 Jalan Anggerik Mokara 31/47
Kota Kemuning, 40460 Shah Alam
Selangor Darul Ehsan, Malaysia
Tel: +603-5121 4286
Fax: +603-5121 4386



中国香港

OGAWA Health Care International(HK) Ltd
31/F,YHC tower,1Sheung Yuet Road
Kowloon Bay
Kowloon
Hong Kong
Tel:+852 3465 6262
Fax:+852 2410 0119



新加坡

OGAWA Health-Care Pte Ltd
27/Tampines Industrial Avenue 5,
T5@Tampines
Singapore 528623
Tel: +065-6846 8588
Fax: +065-6846 7677



越南

OGAWA Vietnam Co Ltd
2nd floor,Petroland Tower,
12 Tan Trao, Tan Phu ward
District 7
Ho Chi Minh
Tel: +848 54133 222/54133 223
Fax: +848 5416 1736



印尼

PT Healthy World
Lodan Center Block O No 20
Jalan Lodan Raya No 2
Jakarta Utara 14430
Tel: +62 21-6983 1123
Fax: +62 21-6983 1124



菲律宾

O-Healthcare Solution Phil. Inc.
2303, 4th Floor,G&A Building,
Chino Roces Avenue Extension,
Makati City,Philippines
Tel : +632 889 0676 / + 632 844 6851
Fax: +632 812 0421



Ogawa is grateful
to have received
these awards:



PUTRA
BRAND AWARDS 2010
SILVER

Ogawa Wellness Hubs : Malaysia . Singapore . Vietnam . Philippines . Indonesia . Myanmar . India . China
Hong Kong . TaiWan . Turkey . Pakistan . Mauritius . Russia . France . Canada
Thailand . Korea . Australia . Dubai . K.S.A . Nigeria . Egypt . Lebanon . Denmark
Sweden . U.S.A

