

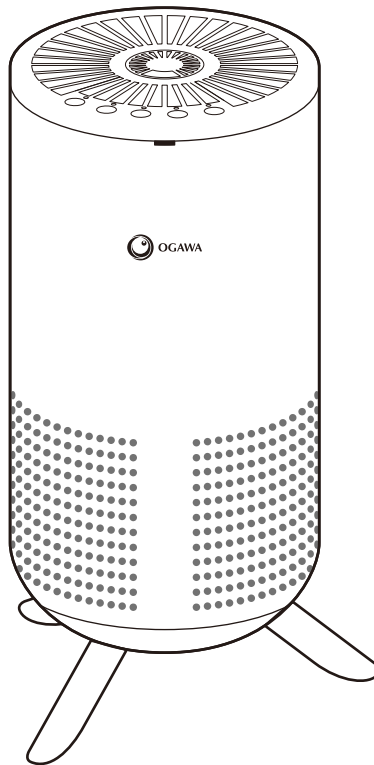

powered by GERMAGIC™
UltiMate
HEPA air purifier

Model
AP1402



- Reads all instruction before using this device
- Keep these manual for future use
- Product image or content may slightly differ due to product quality improvements.

Product Introduction

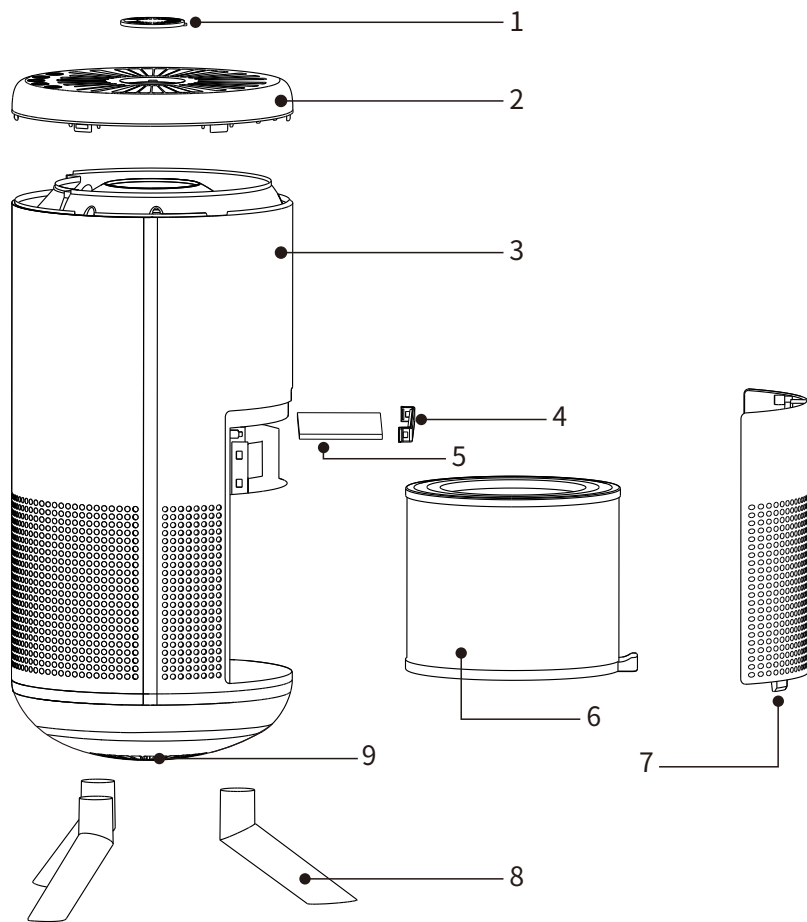

1. Aroma cover 2. Air outlet & control panel 3. Main body 4. Carbon filter
5. Odor Filter 6. Filter 7. Filter casing 8. Stand
9. Air quality light

Product Introduction

Install filter

The filter are supplied within the air purifier. New air purifiers have their filter wrapped to ensure purity. Before use your new air purifier you must remove the plastic wrapper covering the filter.

1. Open the filter casing

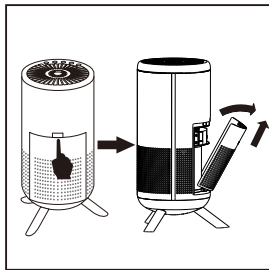

2. Take out the filter and remove the plastic packaging.

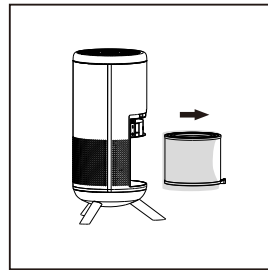

3. Install back the filter on to the machine

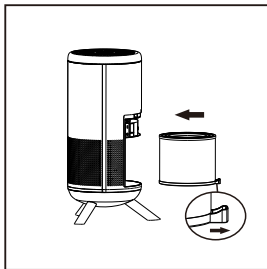

4. Close the filter casing.

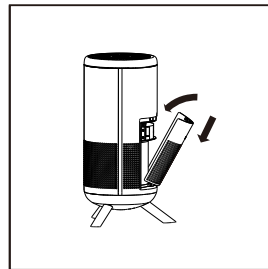

Product Introduction

Control Panel

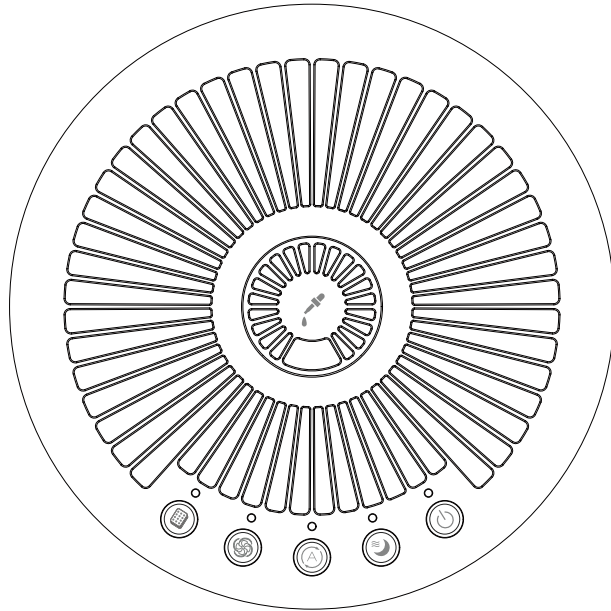

 On/Off button

 Sleep button

 Auto button

 Fan speed button

 Reset button

Product Introduction

Power On

Ensure the air purifier is plugged into working electrical outlet and the power light will illuminate when plugged. Press the power button once, the unit will start at the low fan speed purification .

Sleep Mode

Press this button and indicator light show green will enter sleep mode which sets the purification level to the lowest and turns off the control panel light. Perfect for night time use when sleeping.

Auto Mode

Press this button, the air purifier will adjust the purification according to readings from the air quality level:

Green (Good Air Quality) - Air purifier will operate at low speed

Blue (Medium Air Quality) - Air purifier will operate at medium speed

Red (Poor Air Quality) - Air purifier will operate at high speed

Fan Speed

Press this button, the machine will enter low speed mode (green indicator), press again to switch to medium speed (yellow indicator), press again to enter high speed mode (red indicator).

Product Introduction

Reset button



When reset button is light up, means is time to change the filter. after replace with new filter, long press the button for 3 seconds to reset the lifetime of Germagic filter.

Product Introduction

Replace the filter

Please follow the step bellow to replace filter.

Note:

- This filter is non-washable and nor vacuum cleanable.
- Cleanse your hands after changing the filter.

1. Please turn off the electric socket and unplug from outlet. As shown (a).



2. Open the filter casing. As shown (b).

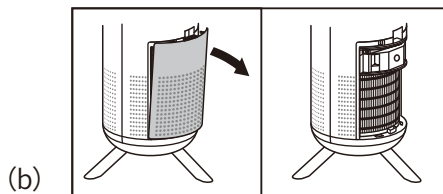

3. Remove out the filter. As shown (c).

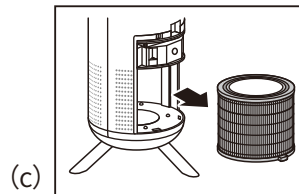

4. Replace the filter. As shown (d).

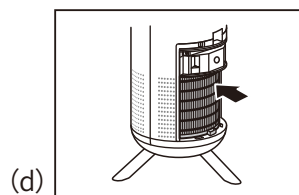

5. Close back the filter casing. As shown (e).

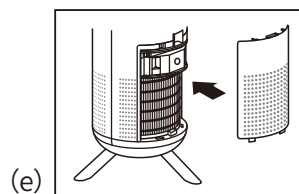

Product Introduction

Add aroma oil

Please follow the step bellow to add aroma oil.

Open the Aroma cover, put the cotton, and add aroma oil.

1. Use finger to open out the Aroma cover

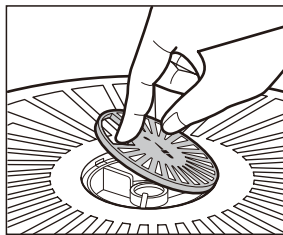

2. Put the cotton and add few drops of aroma oil in it.

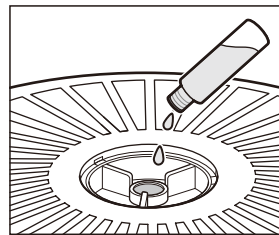

3. Once added, close back the infuser cover back.

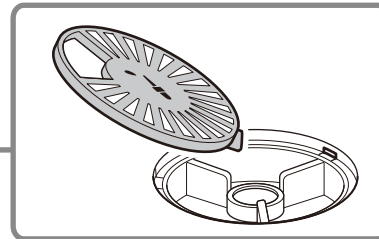
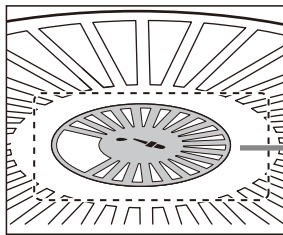

Cotton Replacement

1. Use finger to open out the Aroma cover. As shown (a).

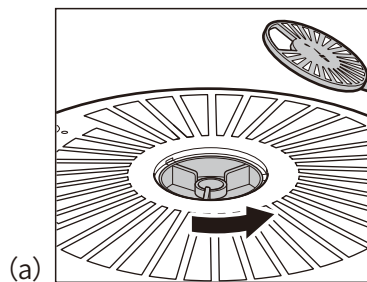

Product Operation

2. Take out the Aroma container, remove the cotton and wash under paip water. As shown (b).

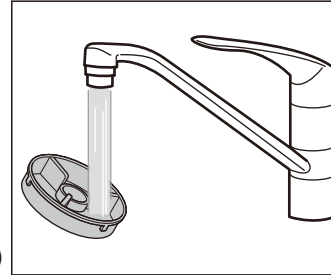

3. Inserts the cotton and install back the Aroma container by twist to left. Then cover it up with the Aroma cover. As shown(c).

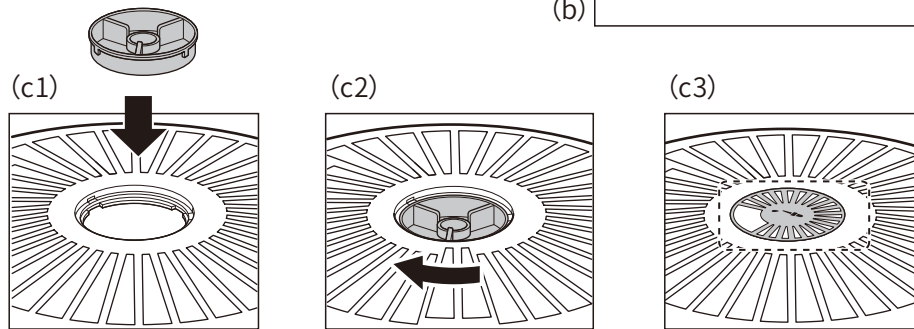

How to install the air purifier stand Snap-in fixing method

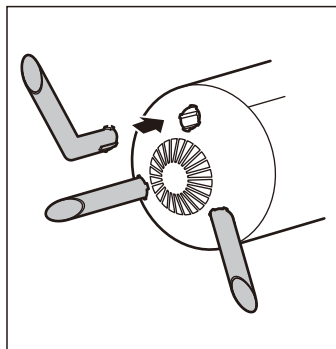

①

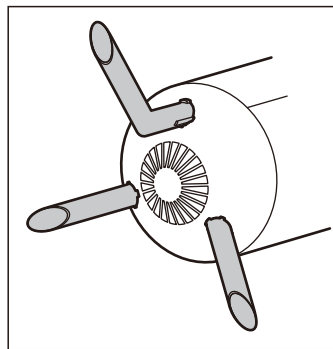

②

Product Introduction

Replace the Carbon Filter

1. Open the filter casing, and remove out the old filter

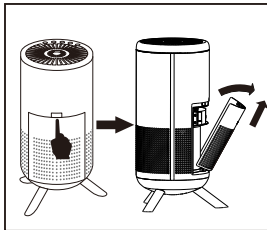

2. Take out the carbon filter.

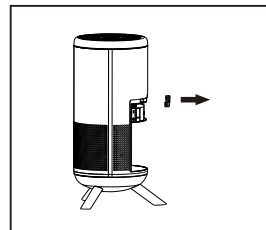

3. Take out carbon filter and remove the plastic packaging

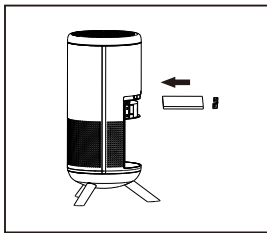

4. Close the filter casing.

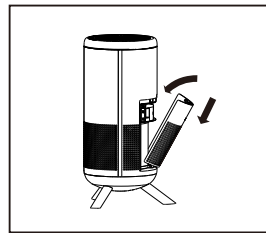

Air Purifier

Note:

- Ensure the power outlet is switch off, before clean the air purifier.
- Do not immerse the air purifier into water or other liquid.
- Do not clean the product with chemical such as thinners, gasoline and alcohol.

Cleaning and maintenance

Regular cleaning the air purifier to prevent the dust accumulate

1. Use dry soft cloth to wipe off the dust on air purifier.
2. Use dry soft cloth to clean air intake and air outlet.
3. Prohibited to use wet cloth to clean air purifier, to prevent liquid from immerse into and cause malfunction.

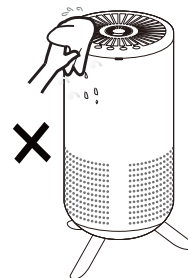



Important Safety Instructions





⚠ **IMPORTANT SAFETY INSTRUCTIONS** READ AND SAVE THESE SAFETY INSTRUCTIONS BEFORE USING THIS AIR PURIFIER

When using electrical appliances, basic precautions should always be followed to reduce the risk of fire, electric shock, and injury to persons, including the following:





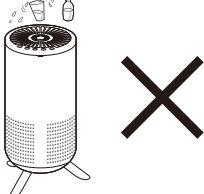
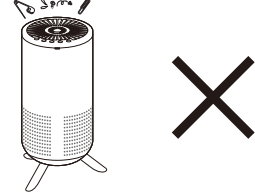



- Read all instructions before operating the air purifier.
 - Place air purifier where it is not easily overturned by persons in the household.
 - **ALWAYS** turn the air purifier controls to the OFF position and unplug from the wall outlet when not in use.
 - To disconnect the air purifier, make sure the unit is powered OFF then grip the plug and pull it from the wall outlet. **NEVER** pull by the cord.
 - **DO NOT** use any product with a damaged cord or plug, any product that malfunctions, or any product that has been dropped or damaged in any manner. Keep the cord away from heated surfaces.
 - **DO NOT** use air purifier outdoors.
 - **DO NOT** use air purifier unless it is fully assembled.
 - **DO NOT** run power cord under carpets, and **DO NOT** cover with throw rugs. Arrange cord such that it will not be a tripping hazard.
 - **DO NOT** use air purifier where combustible gases or vapors are present.
 - **DO NOT** expose the air purifier to rain, or use near water, in a bathroom, laundry area, or other damp location.
 - The air purifier must be used in its upright position.
 - **DO NOT** allow foreign objects to enter ventilation or exhaust opening as this may cause electric shock or damage to the air purifier. **DO NOT** block air outlets or intakes.
 - Locate air purifier near the power outlet and avoid using an extension cord or power strip.
 - This appliance has a polarized plug (one blade is wider than the other). To reduce the risk of electric shock, this plug is intended to fit only one way in a polarized outlet. If the plug does not fit fully in the outlet, reverse the plug. If it still does not fit, contact a qualified electrician. **DO NOT** attempt to defeat this safety feature.
 - A loose fit between the AC outlet (receptacle) and plug may cause overheating and a distortion of the plug. Contact a qualified electrician to replace loose or worn outlet.
 - **DO NOT** sit, stand, or place heavy objects on the air purifier.
 - Disconnect power supply before servicing.
 - **SAVE THESE INSTRUCTIONS.**
- ⚠ **WARNING: To Reduce The Risk of Fire or Electric Shock, Do Not Use This Air Purifier With Any Solid-State Speed Control Device.**
- This appliance is not intended for use by persons (including children) with reduced physical, sensory or mental capabilities, or lack of experience and knowledge, unless they have been given supervision or instruction concerning use of the appliance by a person responsible for their safety.
 - Children should be supervised to ensure that they do not play with the appliance.
 - If the supply cord is damaged, it must be replaced by the manufacturer, its service agent or similarly qualified persons in order to avoid a hazard.

Important Safety Instructions

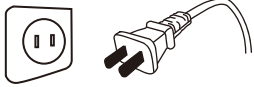
	Actions that must be absolutely forbidden
	Actions tending to cause serious injuries or death
	Actions that must be done

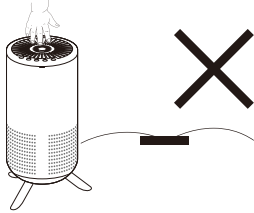
<p> This product is designed for residential use. Do not intend use on outdoor or commercial use.</p> 	<p> Do not operate when the appliance in wet, unstable and unlevel surface.</p> 
<p> Do not let water or any other liquid or flammable detergent enter the appliance to avoid electric shock and/or fire hazard.</p> 	<p> Prevent small foreign item drop into the product.</p> 
<p> Please keep the plastic packaging out of children reach.</p> 	<p> Product are not a toy, dont let children play it.</p> 

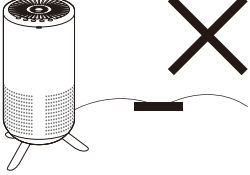
Important Safety Instructions

<p> Ensure that the voltage indicated on the appliance corresponds with the voltage of your electrical outlet. Unplug the appliance from electrical outlet when not in use, and before cleaning.</p> <p></p>	<p> Do not operate the appliance if it has a damage cord or plug, if it is not working properly, or if it had been damage in any manner. The appliance should be service only by qualified service personnel.</p> <p></p>
<p> When the appliance is operate, please dont move the appliance to prevent electric shock.</p> <p></p>	<p> Don't not share the electric socket with other high voltage appliance.</p> <p></p>
<p> Do not use the appliance in a location with major temperature change, humid or high temperature enviornment.</p>	

Troubleshooting

PROBLEM	POSSIBLE CAUSE	POSSIBLE SOLUTION
Unit cannot be switch ON	Power plug is not properly insert into the electrical outlet	Remove the power plug and insert it into the electrical outlet again
	Unit is not switch ON	Ensure the power plug is properly inserted into the electrical outlet and switch on the unit.
Poor performance or not purifying at optimum capacity	Plastic packaging on filters are not removed	Remove plastic packaging on filter before using
	Filter unit is due for replacement	Replace with a new set of filter unit.
	No adequate clearance and space around the unit for air ventilation	Ensure the air inlet on both sides of the unit has a clearance of at least 40cm.
	Sleep mode is activated. The LED indicator is dim off. The fan speed and noise is adjust at minimal.	Long press the fan speed button to select the suitable speed.
The fan speed did not auto adjust	The infrared VOC sensor is getting wet or the room temperature is too high cause sensor failure.	Please ensure the infrared VOC sensor dry and clean.
Product have abnormal sound	Plastic packaging on filters are not removed	Remove plastic packaging on filter before using
The air quality indicator remain the same	The room is not well ventilated	Please open the window to improve the air ventilation.
After change filter, the change filter light keep flashing	The reset button is not correctly press	Re-install the filter

Product Name	UltiMate
Model number of the product	AP1402
Voltage	100-240V
Power frequency	50-60Hz
Power consumption	25W
Dimensions(Length/width/height)	φ245*H560mm
Weight	4.3±0.2kg

COATED HEPA BY GIRD IN ACCORDANCE TO SECTION 2.1.1.10 OF TECHNICAL STANDARDS FOR DISINFECTION

VIRUS (30S CONTACT)	ELIMINATION RATE
MERS-COV	98.8% (60 MIN CONTACT)
H1N1 INFLUENZA A VIRUS	>99.999% (60 MIN CONTACT)
INFLUENZA B VIRUS	>99% (60 MIN CONTACT)
ENTEROVIRUS 71	>99% (30 MIN CONTACT)
H1N1 SWINE FLU OR NOVEL INFLUENZA A	>99.9% (60 MIN CONTACT)
H3N2 HONG KONG FLU VIRUS	>99% (60 MIN CONTACT)
H7N9 AVIAN INFLUENZA	>99.9% (60 MIN CONTACT)

COATED FILTER BY EUROFIN(S) IN ACCORDANCE TO ISO 20743:2013

BACTERIA	ELIMINATION RATE
STAPHYLOCOCCUS AUREUS (ATCC 6538P)	>99.99%
KLEBSIELLA PNEUMONIE (ATCC 4352 - DSM789)	>99.99%

Contact Us



MALAYSIA
Healthy World Lifestyle Sdn Bhd
No. 22 Jalan Anggerik Mokara 31/47
Kota Kemuning, 40460 Shah Alam
Selangor Darul Ehsan, Malaysia
Tel : +603-5121 4286
Fax: +603-5121 4386



HONG KONG, CHINA
OGAWA Health Care International (HK) Ltd
31/F,YHC Tower,1Sheung Yuet Road
Kowloon Bay
Kowloon
Hong Kong
Tel:+852 3465 6262
Fax:+852 2410 0119



SINGAPORE
OGAWA Health-Care Pte Ltd
27 Tampine Industrial Avenue 5,
T5 @ Tampines
Singapore 528623

Tel:+065-6846 8588
Fax:+065-6846 7677



VIETNAM
OGAWA Vietnam Co Ltd
2nd floor,Petroland Tower,
12 Tan Trao,Tan Phu ward
District 7
Ho Chi Minh
Tel:+84 8 3775 3093/3775 3094
Fax:+84 8 3775 3095



PHILIPPINES
O-Healthcare Solution Phil.Inc.
2303, 4th Floor, G&A Building,
Chino Roces Avenue Extension,
Makati City, Philippines
Tel : +632 889 0676 / +632 844 6851
Fax: +632 812 0421