

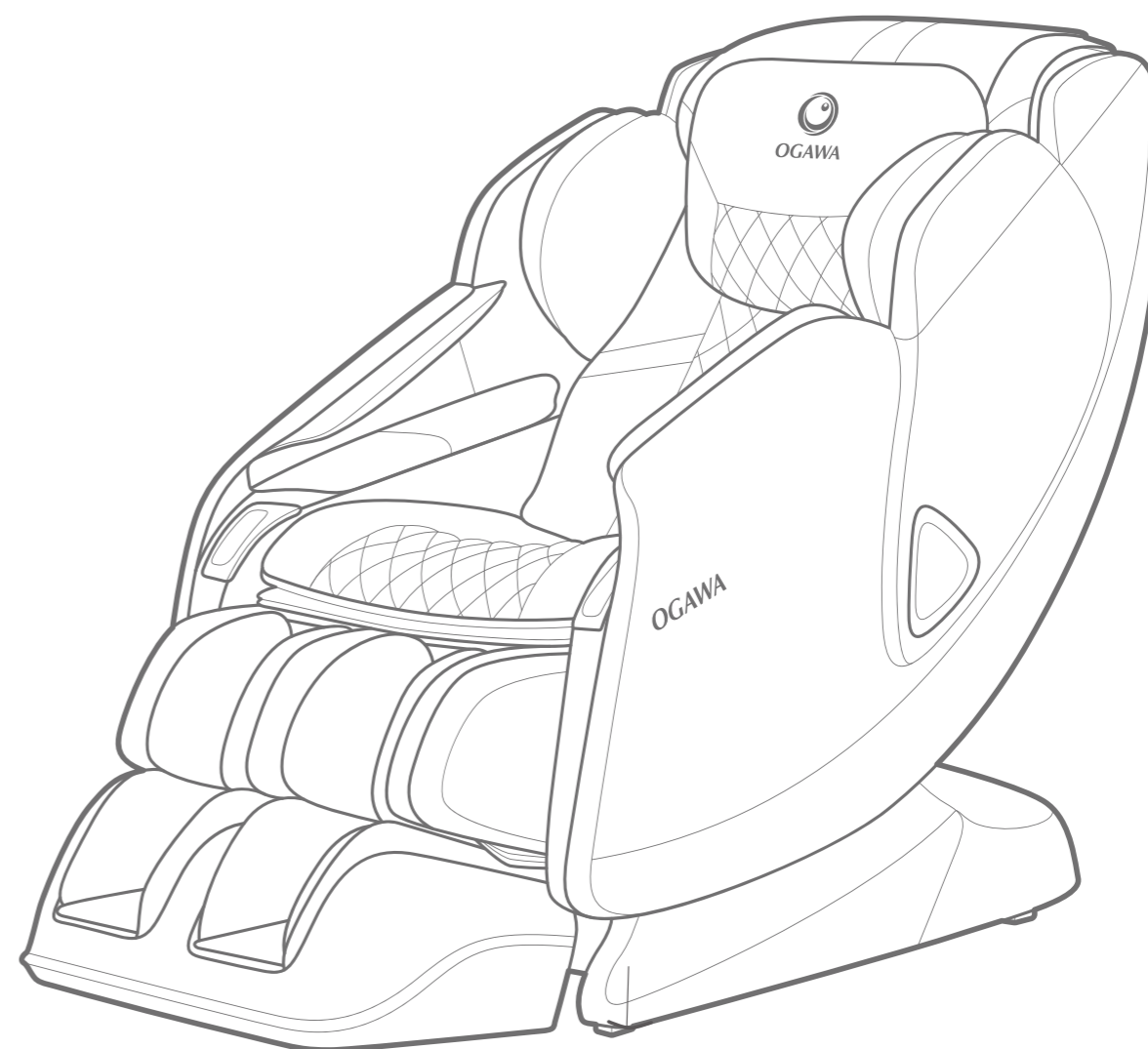

SMARTRELUXE

MASSAGE CHAIR 按摩椅



Ogawa is grateful to have received these awards:



PUTRA
BRAND AWARDS 2010
SILVER
In association with
MALAYSIA'S MOST VALUABLE BRANDS

Ogawa Wellness Hubs : Malaysia . Singapore . Vietnam . Philippines . Indonesia . Myanmar . India . China
Hong Kong . Taiwan . Turkey . Pakistan . Mauritius . Russia . France . Canada
Thailand . Korea . Australia . Dubai . K.S.A . Nigeria . Egypt . Lebanon . Denmark
Sweden . U.S.A

This user manual is also can be download via internet: www.ogawa.com.cn

User Manual
OG6383使用手册



SMART RELUXE MASSAGE CHAIR

User manual
All information is correct at the time of print

Before Use

- Important safety instructions 01 - 04
- Grounding instructions 05
- Setup of the massage lounger 06 - 07
- Before use 08 - 09
- Product parts 10 - 12

How to use

- Operation Guide 13 - 16
- After massage 17

Maintenance

- Cleaning and maintenance 18



Q&A/Important notes

- Q&A 19
- Troubleshooting 20-21
- Specification 22
- Contact Us 23

Important safety instructions Must be followed



These safety instructions must be strictly followed in use to avoid personal injuries and property damage as follows:



■ All the safety instructions are described in compliance with degrees of the injuries or damage as a result of wrong use.

 Warning	Actions tending to cause serious injury or death
 Caution	Actions tending to cause minor injuries or property damage



■ Pay attention to the symbols before safety instructions(an example is given below).

 Actions that must be absolutely forbidden	 Actions that must be done
--	--





 Warning			
 Must be followed	<ul style="list-style-type: none"> ● Before using the product, persons who are being treated or have any of the following symptoms should consult a physician. <table border="0" style="width: 100%; font-size: small;"> <tr> <td style="vertical-align: top;"> (1) pacemaker or another in-vivo electronic medical device tending to suffer electronic jamming; (2) Patients with malignant tumors; (3) Patients with heart disease; (4) Persons proved to be unable to identify temperatures; (5) Pregnant persons or women who have just had childbirth; (6) Persons with perceptual disturbance because of diabetes or another serious peripheral circulation disturbance; (7) Osteoporosis patients, spinal fracture patients, or persons with acute painful diseases such as sprains or muscle strains; </td> <td style="vertical-align: top;"> (8) Persons with injuries in the massaged parts; (9) Persons with a body temperature above 38 C (with a fever)(For example, persons with intense acute inflammation symptoms such as listlessness, cold shivers and blood pressure change or persons in poor health) ; (10) Persons who are unwell or must have a rest; (11) Persons with an abnormal or bent vertebra; (12) Persons with protrusion of intervertebral disc; (13) Persons who feel very uncomfortable(except for the circumstances above) </td> </tr> </table> <p>Otherwise accidents or physical discomfort may happen.</p>	(1) pacemaker or another in-vivo electronic medical device tending to suffer electronic jamming; (2) Patients with malignant tumors; (3) Patients with heart disease; (4) Persons proved to be unable to identify temperatures; (5) Pregnant persons or women who have just had childbirth; (6) Persons with perceptual disturbance because of diabetes or another serious peripheral circulation disturbance; (7) Osteoporosis patients, spinal fracture patients, or persons with acute painful diseases such as sprains or muscle strains;	(8) Persons with injuries in the massaged parts; (9) Persons with a body temperature above 38 C (with a fever)(For example, persons with intense acute inflammation symptoms such as listlessness, cold shivers and blood pressure change or persons in poor health) ; (10) Persons who are unwell or must have a rest; (11) Persons with an abnormal or bent vertebra; (12) Persons with protrusion of intervertebral disc; (13) Persons who feel very uncomfortable(except for the circumstances above)
	(1) pacemaker or another in-vivo electronic medical device tending to suffer electronic jamming; (2) Patients with malignant tumors; (3) Patients with heart disease; (4) Persons proved to be unable to identify temperatures; (5) Pregnant persons or women who have just had childbirth; (6) Persons with perceptual disturbance because of diabetes or another serious peripheral circulation disturbance; (7) Osteoporosis patients, spinal fracture patients, or persons with acute painful diseases such as sprains or muscle strains;	(8) Persons with injuries in the massaged parts; (9) Persons with a body temperature above 38 C (with a fever)(For example, persons with intense acute inflammation symptoms such as listlessness, cold shivers and blood pressure change or persons in poor health) ; (10) Persons who are unwell or must have a rest; (11) Persons with an abnormal or bent vertebra; (12) Persons with protrusion of intervertebral disc; (13) Persons who feel very uncomfortable(except for the circumstances above)	
	<ul style="list-style-type: none"> ● If you feel physically abnormal while using or no effect after use, stop the product immediately and consult a physician about it. Otherwise accidents or physical discomfort may happen. 		
	<ul style="list-style-type: none"> ● Before being massaged or moving the backrest or the lower Leg/Foot massage section, make sure there is no people or pet close to the product(in front, behind, below or on the side) ● Before use, make sure there is no foreign matter between the backrest and the back cover. Otherwise accidents or physical discomfort may happen. 		
	<ul style="list-style-type: none"> ● Before use, lift the back cushion and check whether fabric of traveling sections of the massage wheels or of other positions are damaged. (Even if the fabric is slightly damaged, stop the product immediately, pull out the power plug and send the product to repair.) If the product is used when the fabric is damaged, you may get injured or get an electric shock. 		
	<ul style="list-style-type: none"> ● Do not massage for more than 30 minutes each time. ● Do not massage a single part for more than 5 minutes. If any of these safety instruction is not followed, you may suffer an adverse effect and be injured. 		
	<ul style="list-style-type: none"> ● After use each time, turn the power switch to the "O" position, then pull out the power plug. Otherwise accidents or injuries may happen due to naughty behaviors of children. 		
	<ul style="list-style-type: none"> ● Follow the regulations about use of the socket and the wiring devices. ● Use a 220-240V~, 50-60Hz power supply. (Do not use the product in a foreign country or connect it with a transformer without permission.) Otherwise electric shocks, product faults or fires because of overheat may happen. 		
	<ul style="list-style-type: none"> ● Insert the power plug thoroughly into the socket. Otherwise electric shocks or fires cause by overheat may happen. 		

 Warning	
 Must be followed	<ul style="list-style-type: none"> ● Remove such dirt and dust on the power plug at regular intervals. Otherwise fires caused by poor insulation due to factors such as moisture may happen. (Wipe the power plug with dry cloth.)
	<ul style="list-style-type: none"> ● In the case of any abnormality or fault, stop the product immediately and pull out the power plug to avoid smoke, fires and electric shocks. (Abnormality and fault examples) <ul style="list-style-type: none"> • The product fails to work after the power switch is turned to the ON position; • After the power line is moved, the product is discontinuously powered on; • In use, the product gives off a burning smell or an abnormal sound; • The product is deformed or abnormally heating; <p>→ In any of these abnormalities and faults, have the product inspected and repaired by an authorized service center immediately.</p>
 Forbidden	<ul style="list-style-type: none"> ● Do not put the back cushion between the backrest and the back cover. Otherwise product faults may happen.
	<ul style="list-style-type: none"> ● When handling the product, hold its frame. Otherwise product faults or personal injuries may happen.
	<ul style="list-style-type: none"> ● The following persons should not use the product. Persons for whom massage is forbidden by doctors, such as persons with thrombosis, serious aneurysm, acute venous aneurysm, various skin inflammations(such as subcutaneous tissue inflammation) or various skin infections. Otherwise diseases may get worse.
	<ul style="list-style-type: none"> ● The following persons should not massage their waists. <ul style="list-style-type: none"> • Persons with acute lumbago, protrusion of intervertebral disc, or displacement of a lumbar vertebra; • Persons with the deformation or other discomfort of the hip joint; Otherwise diseases may get worse.
	<ul style="list-style-type: none"> ● Do not put hands, arms or feet into the backrest's fabrics of traveling sections of the massage wheels. ● Children should not use the product. Keep them from playing on the product or climbing onto the Lower Leg/Foot massage section, the seat, the backrest or the armrests. ● Do not climb onto the backrest or the armrests. ● Do not lean or sit on the backrest. ● Keep your head from reachable areas of the backrest and the back cover. ● Persons unable to express themselves clearly or unable to operate the product should not use the product. ● When massaging the neck, pay attention to moving directions of the massage wheels and do not massage with a too large force or massage front part of the neck. Otherwise accidents or personal injuries may happen.
	<ul style="list-style-type: none"> ● Do not damage the power line or the power plug. (Do not damage, machine, forcibly bend, twist or prolong the power line or the power plug, or place the power line or the power plug close to a heater, or tie or bind any heavy objects on the power line or the power plug.) A damaged power line or power plug may result in electric shocks, short circuit faults or fires. Please consult the shop from which you bought the product or a designated authorised service center about maintenance method of the power line or the power plug.
	<ul style="list-style-type: none"> ● Do not use the Waist Warm massage for a long time Otherwise you may get low-heat burns. * Even if the temperature is relatively lower (40 C ~60 C), low-heat burns may happen after longtime contact with skin (in spite of no obvious hot or painful feeling).
	<ul style="list-style-type: none"> ● Do not damage the Knee Warm(heater) section. <ul style="list-style-type: none"> • Do not insert pins or needles into the product. • Do not cut the product with a cutter. If the internal heater is damaged, fires or electric shocks may happen.
	<ul style="list-style-type: none"> ● Do not insert or pull out the power plug with the wet hands. Otherwise electric shocks may happen.
	<ul style="list-style-type: none"> ● Do not refit, disassemble or repair the product with out permission. Otherwise fires, abnormal movements or personal injuries may happen.

 **Caution**

 Must be followed	<ul style="list-style-type: none"> ● The following persons (even if they are physically healthy at present) should consult a physician before using the product. <ol style="list-style-type: none"> (1) Persons with muscular atrophy due to aging or thin persons; (2) Persons feeling lumbago because of bone or viscus problems; (3) Persons tending to suffer sprains or bruising; (4) Persons with carsickness or seasickness or strong response when taking other transport means; (5) Persons who once received a heart operation or another visceral operation; Otherwise health may get worse.
	<ul style="list-style-type: none"> ● Before sitting on the product, make sure there is no foreign matter between any two parts of it. (Make sure there is no foreign matter on the back cover, the backrest, the seat surface, the Lower Leg/Foot massage section or inside surface of the back cushion.) Otherwise accidents, injuries, or product faults caused by clamping of hands, feet, or other articles by the product may happen.
	<ul style="list-style-type: none"> ● Do not use the product when wearing any hard decorative article on head(such as hair pin). ● If there is any hard article (such as mobile phone or key) in a pocket of the trousers, take it out before massage. ● Before hand or arm massage, remove watch, nail wrap, ring, etc. Otherwise injuries may happen.
	<ul style="list-style-type: none"> ● Before sitting on the seat, make sure the massage wheels are in the retracting positions. ● If you want to leave the seat during the massage, stop the product first. Otherwise injuries may happen.
	<ul style="list-style-type: none"> ● When pulling out the power plug, do not pull the power line but hold the power plug. Otherwise an electric shock or a short circuit fault may happen.
	<ul style="list-style-type: none"> ● Before moving the product, make the Lower leg/Foot massage section back to the original position by adjusting its angle. Otherwise injuries may happen.
	<ul style="list-style-type: none"> ● When moving the product by pulleys, put articles such as mats on the floor. Otherwise marks may be left on the floor.
	<ul style="list-style-type: none"> ● Keep children from the retaining screws on the remote controller holder. Otherwise children may cause accidents or suffer injuries by eating it or playing with it.
	<ul style="list-style-type: none"> ● Before moving the product by pulleys, remove the obstructions close to it. Lift the seat surface of the Lower leg/Foot massage section to a position a little lower than the waist and move the product slowly. Otherwise accidents or injuries may happen because of turnover of product.
	<ul style="list-style-type: none"> ● In use, place the product horizontally. Otherwise accidents due to turnover of the product may happen.
	<ul style="list-style-type: none"> ● If any symptom such as skin inflammation, itching or swelling in use, stop the product immediately and consult a physician. Otherwise accidents or physical discomfort may happen.
	<ul style="list-style-type: none"> ● If the product is used again for massage after a period of out-of-service, read the operating instructions again and make sure the product can run normally first. Otherwise accidents or injuries may happen.
	 Forbidden
<ul style="list-style-type: none"> ● Keep head abdomen or skin from the massage wheels and do not put hands or feet between the massage wheels. ● Do not put the knees between the Lower Leg/Foot massage section. ● Do not fall asleep while using the product. Do not use the product after drinking. ● If air in the filling of the air bag on the seat is not completely discharged, do not stand or jump on the seat or put things on it. Otherwise accidents or injuries may happen. 	

 **Caution**

 Forbidden	<ul style="list-style-type: none"> ● Do not put hands or feet between the product and the Lower Leg/Foot massage section. ● Do not put hands, arms, or head into the seam of the Lower Leg/Foot massage section(footrest). For safety, admit the Lower Leg/Foot massage section after massage. ● Do not put hands, feet or head between the backrest and the back cover. ● Do not put pets on the product (such as its back cover, backrest and armrest). ● Do not pull out the power plug or turn OFF the power switch suddenly during massage. Otherwise injuries may happen. 	
	<ul style="list-style-type: none"> ● Do not stand or sit on the back cover. Otherwise personal injuries due to the product toppling may occur. 	
	<ul style="list-style-type: none"> ● Do not stand or sit on the armrests. Otherwise personal injuries may happen. 	
	<ul style="list-style-type: none"> ● Do not stand or sit on the Lower Leg/Foot massage section or the footrest. Otherwise accidents or injuries due to rotation of front of the footrest or turnover of the product may happen. If bottom of the Lower Leg/Foot massage section runs into floor, the floor may be damaged. 	
	<ul style="list-style-type: none"> ● Do not drag or push the product after it is installed. Otherwise the floor may be damaged. 	
	<ul style="list-style-type: none"> ● Do not move the product while there is a person on it. Otherwise, accidents, or injuries may happen due to a toppling of the product. 	
	<ul style="list-style-type: none"> ● Do not use the product on heating devices such as electric blankets. Otherwise fires may happen. 	
	<ul style="list-style-type: none"> ● Do not put the remote controller on the product. Otherwise the product may be damaged. 	
	 Wet-hand contact forbidden	<ul style="list-style-type: none"> ● Do not use the product in a bathroom or another wet place. Otherwise electric shocks or product faults may happen.
	 Product wetting forbidden	<ul style="list-style-type: none"> ● Do not sprinkle substances such as water on the product or its remote controller. Otherwise electric shocks, short circuit, or product faults may happen.
 Pull out the power plug	<ul style="list-style-type: none"> ● Before cleaning or maintaining the product, pull out the power plug first. Otherwise electric shocks or injuries may happen. 	
	<ul style="list-style-type: none"> ● In the case of a power failure, pull out the power plug at once. Otherwise accidents or injuries may happen when power is restored. 	
	<ul style="list-style-type: none"> ● When the product is not used, pull out the power plug. Otherwise electric leakage fires may happen because of insulation aging cause by dust and moisture. 	

Grounding instructions

- The product must be grounded to reduce the electric shock hazard because of functional faults of the product.
- The product has a power line with a grounding conductor and a grounding plug. The grounding plug must be inserted into an appropriate socket that has been correctly installed and grounded in full compliance with the local code and decree.

Caution

- If the grounding conductor is not correctly connected, electric shocks may happen. If you are not sure about correctness of the grounding, have it inspected by a professional electrician. Even if the grounding plug provided with the product does not match with the socket you have, do not refit it by yourself but ask a professional electrician to install an appropriate socket.
- The product has a grounding plug. Make sure the product is connected with a socket matching with shape of the grounding plug.
- Do not connect the product to a multi-plug.
- If the power plug is damage, it must be replaced by a special plug available from OGAWA or authorize agents.
- The product has a heat surface, people who are not sensitive to heat must pay attention to it!

1. This appliance can be used by children aged from 8 years and above and persons with reduced physical, sensory or mental capabilities or lack of experience and knowledge if they have been given supervision or instruction concerning use of the appliance in a safe way and understand the hazards involved.
2. Children shall not play with the appliance. Cleaning and user maintenance shall not be made by children without supervision
3. The appliance has a heated surface. Persons insensitive to heat must be careful when using the appliance.
4. The appliance is intended for indoor use only.

Setting of Massage Chair

1 Installation site

Please be sure there is enough space for the massage chair to tilt.

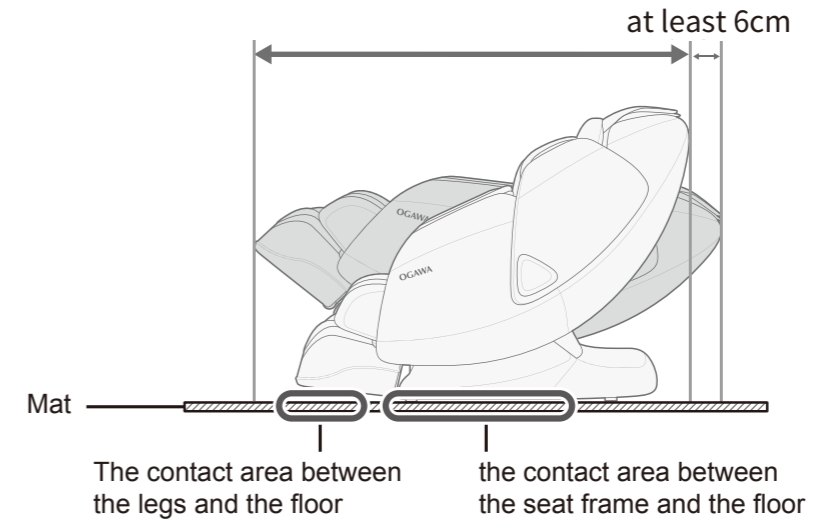

- Do not expose the massage chair to the direct sunlight or high temperature condition (e.g. in front of heating equipment), as it may lead to color fading or hardening of the synthetic leather of the massage chair.
- Please lay a mat under the machine to avoid causing damage to the floor. When laying the mat, the size of mat should be big enough to cover the contact area between the machine and the floor and the foot contact area. Floor area (at least 200cmx90cm), as shown in the figure.
- It should keep close to the power socket when the machine is installed.

2 Description of product movement

Method 1: Hold the two bottom sides of the seat frame before lifting and moving it.



- Due to the heavy weight of the machine, please handle it with care, so as not to cause strain of back. (The machine must be handled by two or more people.)

Product weight	Approx 83.5kg
----------------	---------------

※ Caution

1. Please lift and move the massage chair on the damageable floor, such as wood floor.
2. Please stretch your hands into the bottom of the seat frame to hold the steel frame and lift it, so as not to damage the plastic parts on the outside of the seat frame.

Place the machine on the floor.

- Put the machine down slowly and be careful not to crush your foot.
- Do not let go of the legs of the machine until it is kept completely flat. A sudden loosening will cause the legs being rebound to its original position.
- The floor may be damaged. Therefore, it is suggested to lay things like mat on the floor.



Caution

- Do not drag or push the machine when it is not completely installed.
- Do not hold the side plate or the plastic parts on the outside of the seat frame to move it. Otherwise, it is easy to cause machine fault or personal injury.
- If you need to use the rear castor to move the machine, you are recommended to lay a mat under the moving position, so as not to scratch the floor.
- Do not move the machine when someone is seated. Otherwise, it may cause machine fault or personal injury due to a fall.
- Please turn off the machine and ensure that the backrest and the foot are completely reset before moving the machine. Otherwise, it may cause machine fault or personal injury.

Method 2: Use the rear castor to move the massage chair.



Caution

If using the rear castor to move the machine, please lay a mat on the floor; or it may leave scratches on the floor.

- 1 Press the “on / off” key to turn off all functions.
- 2 Reset the backrest and legs of the machine to the original position. Set the power switch below the rear of the machine to the position “o” (off) and unplug the power plug.

Tilt the massage chair downward and backward about 45 degrees before moving it, according to the methods shown.

Note: The movement range should be moderate when pushing it down, so as not to cause damage to the hood due to the complete tilting of the chair.

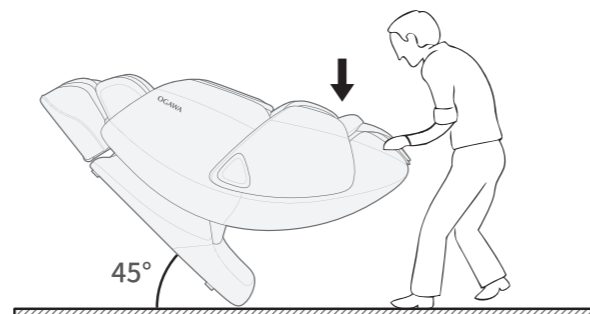

Before use

1 Check the surroundings

Make sure there is no people, pet and other object around the machine.

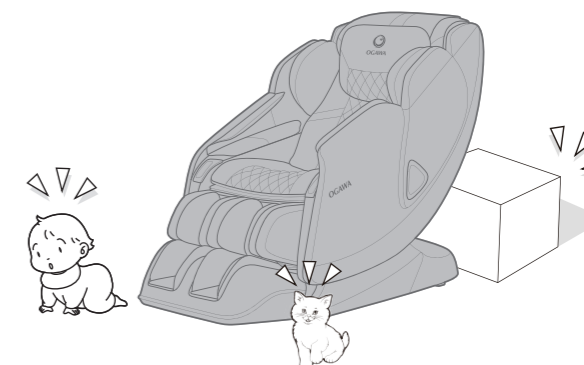

2 Make sure there is no foreign object in the gap of the machine.

Before massage, please ensure that there is no foreign object in the legs and foot and other positions.



Caution

- Do not stretch your hands, fingers, feet and head into the gap between the legs and the seat and between the legs and the armrest.
- Please ensure that there is no foreign object between the parts of the machine before having a seat.
- Do not stretch your hands, arms or head into the gap between the backrest and the rear cover.
- Do not put your pets on massage chairs (seat, backrest, armrests, legs, etc.).

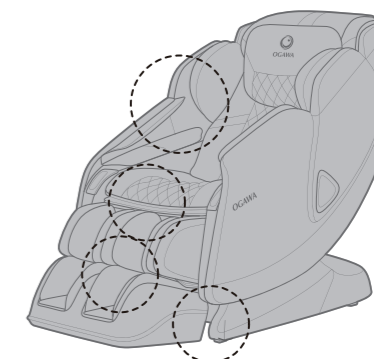

3 Power on.

Before massage, please ensure that there is no foreign object in the legs and foot and other positions.

- 1 Insert the power plug into the power socket.

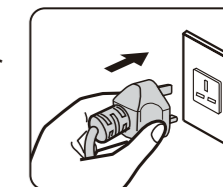

- 2 Set the power switch under the machine to the position “I” (open).

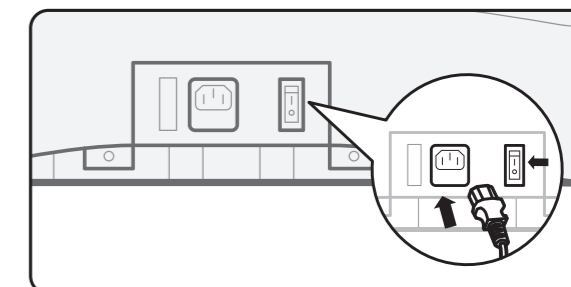

Warning

- Before use, please check whether the power cord and power plug are damaged or not.
- Please ensure that there is no foreign object between the parts of the machine before having a seat. Please be sure to insert the power plug into the end. Otherwise, it may cause electric shock or fire due to overheating.
- Please use 220-240V ~ 50-60Hz alternating current. Do not use this product overseas or connect it to the transformer without permission. Otherwise, it may cause electric shock, machine fault or fire due to overheating.
- Do not plug and unplug power plug with wet hands.

Before use

4 Ensure that the massage wheel is in the storage position.

When the massage wheel is not in the storage position, press the “on / off” key to return it to the storage position.



Press the “on / off” key to return it to the storage position.



5 Ensure that the fabric is not damaged and cracked.

Key inspection area: Fabric of the backrest covered on the moving range of the massage wheel.

Caution

- Before use, you must first open the back cushion to check whether the fabric in the key areas is damaged. And the fabric in other parts should be also checked to make sure it is not damaged. (No matter how small the damage is, please stop using it immediately, unplug the power plug and send it to repair.) The use of the machine in case of damaged fabric may cause danger of injury or electric shock.

Key inspection area

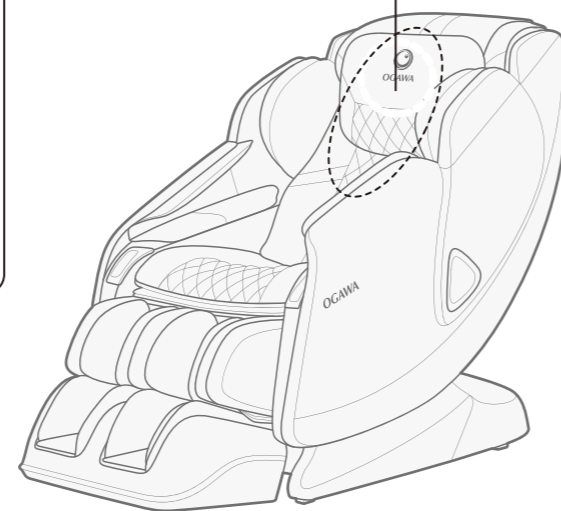

Product Parts

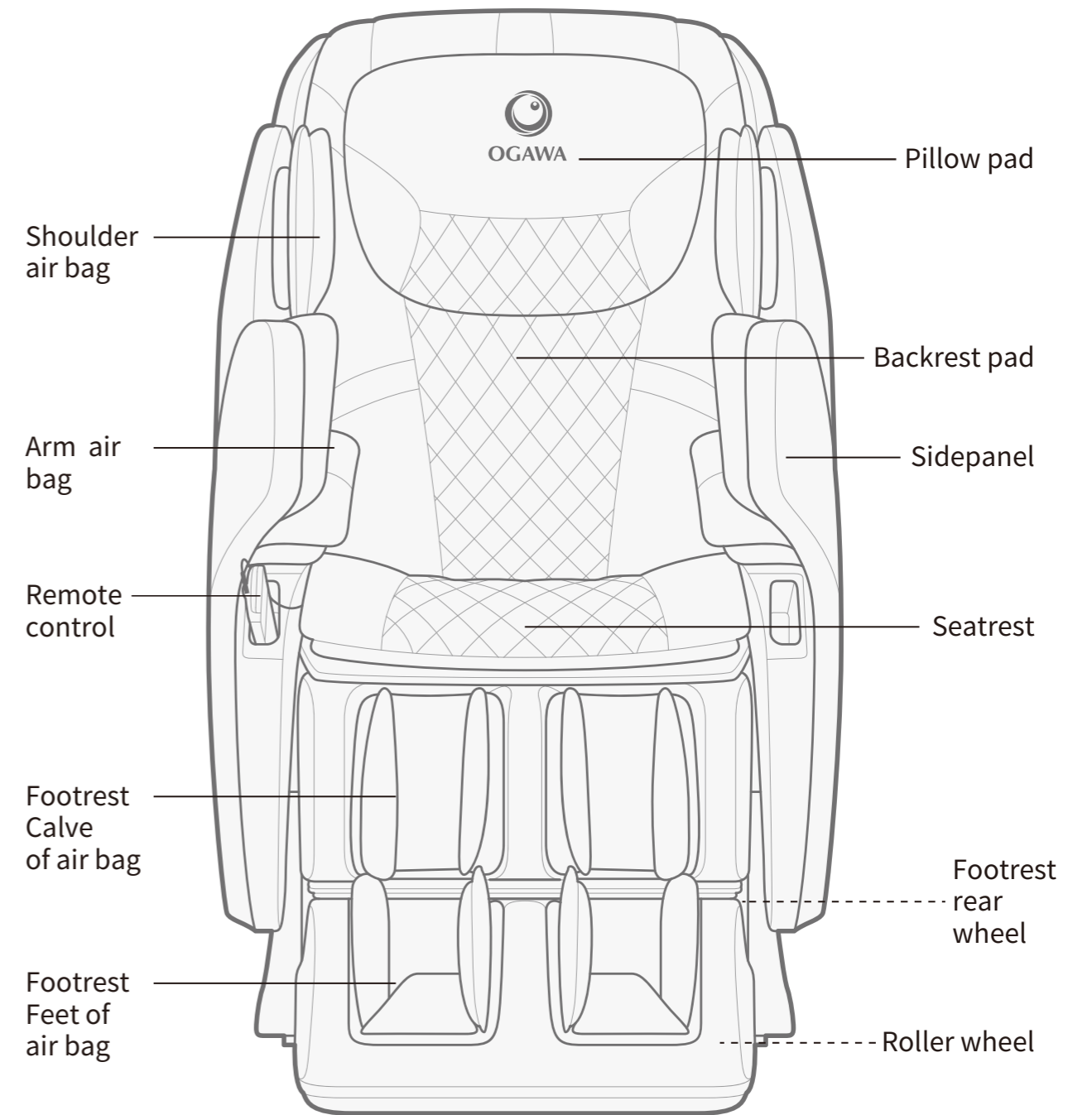

Product Parts

Function distribution diagram

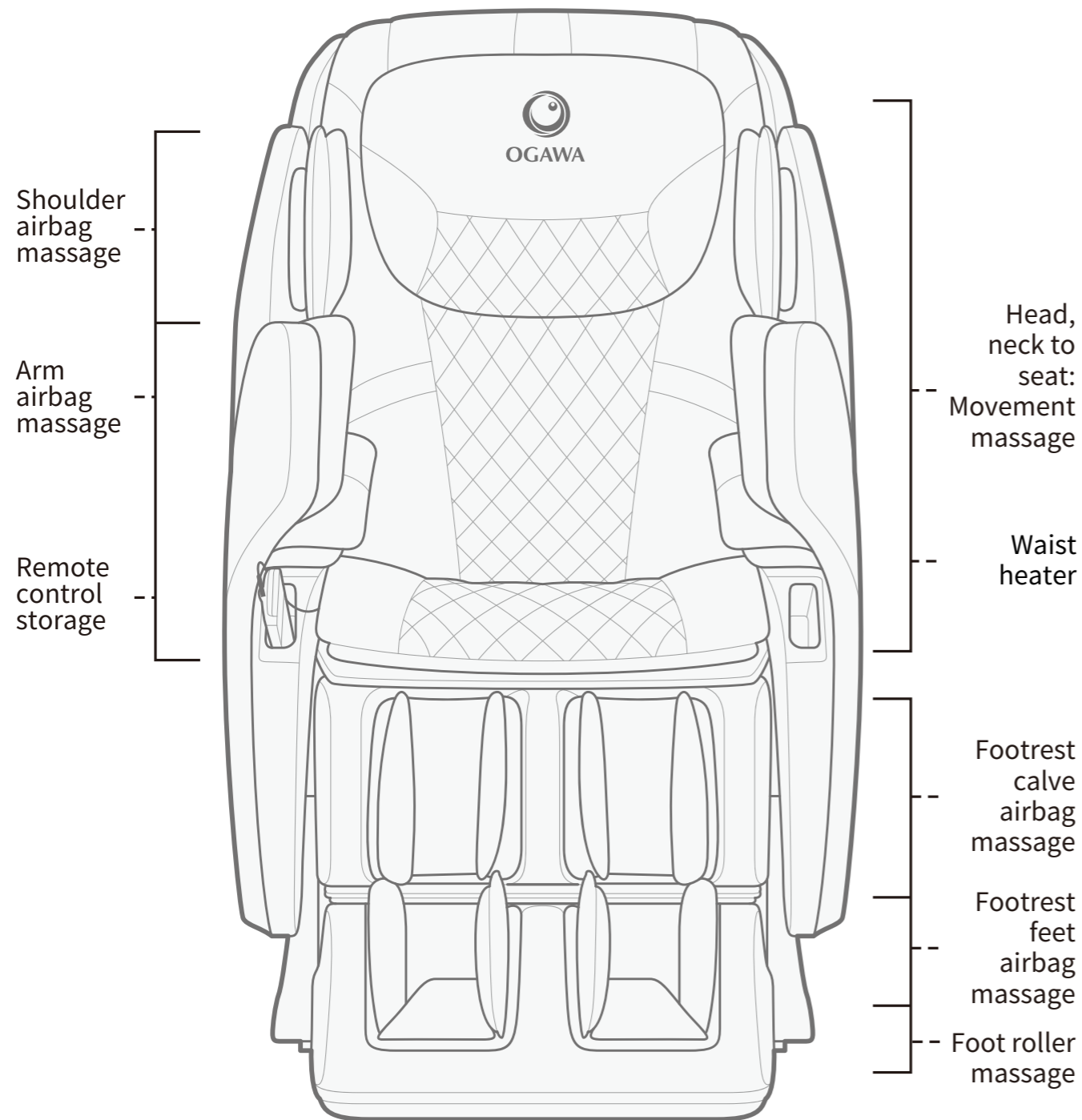

Product Parts

Controller

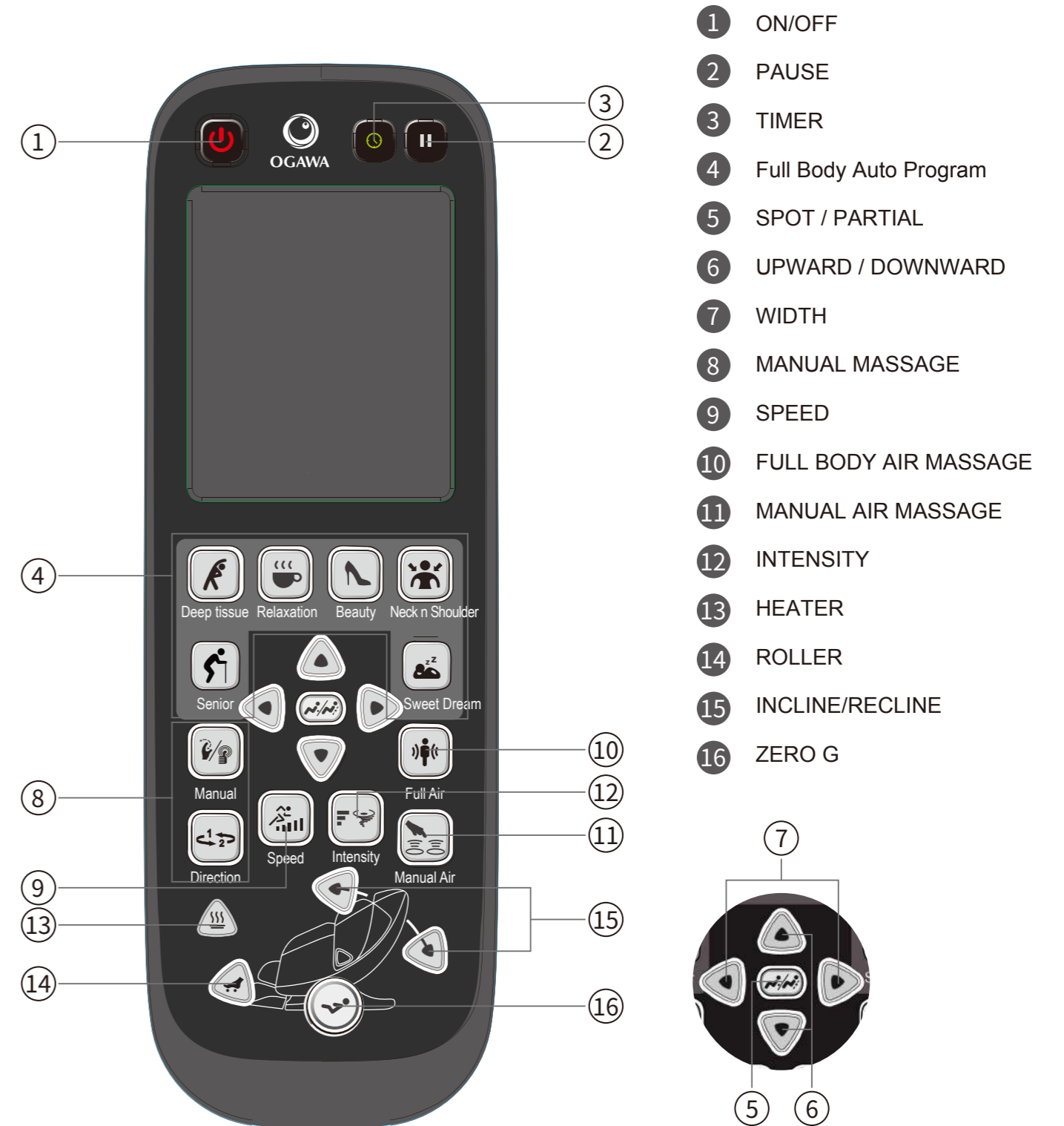

Product Operation Guide

I. Please take note on below information when using this product:

Connect to the power supply and turn the switch to "I" position, and the chair is now in idle mode. During this idle mode, the ON/OFF button will blink, which mean the electric supply is connected. During its idle mode, there are only six function: ON/OFF, Pause, Incline, Recline and Zero G.

II. Control button for massage chair

1. ON/OFF button

Start stop control button

Press once on this button, the LCD backlight and ON/OFF button will lit.
Press any massage function button to begin the massage chair function.
This will also start the timer. Press this button again to stop all massage function and the massage roller will return back to the origin position.

2. Pause

The Pause button

When the chair is in the massage mode and user want to temporary pause it, press the Pause button and all massage button will stop. The Pause button will blinking and the set time countdown will pause as well. Press the Pause button again to immediately cease the pause function and resume the original massage function. The countdown will continue.

3. Timer

Time interval control button

When a massage function is activated, the time is preset at 15 minutes.
Every time this button is pressed, it will change the time interval sequence at "20>25>30>5>10>15>20" minutes.

4. Full Body Auto Program

When either 1 of 6 auto program is activated, the chair will automatic perform a shoulder height scan. The user can manually adjust the shoulder height position to the desired comfort.

6 Auto massage program

Deep tissue
Relaxation
Beauty
Neck n Shoulder
Senior
Sweet Dream

5. Spot / Partial

Press this button once to activate the Spot massage at the required location. Press this button again to switch to Partial function. The massage will take the spot position as center to perform partial massage at a distance of approximate 8cm. Press again to stop the function.

6. Upward / Downward button

When the spot or partial massage was activated, press and hold the button to move the massage roller upward / downward. Release the button when the desired location is reach.

Remark: During shoulder height scanning, if require to do adjustment, press this 2 button to do fine tune within 10 second.

7. Width adjustment

The width adjustment for Tapping, Shiatsu, Clapping, Rolling

After activated the Tapping, Shiatsu, Clapping or Rolling function, you can press this button to adjust the massage width to "narrow> medium> large" in a cycle.

8. Manual Massage Function

Press this button to activate manual massage, press again to change the "massage "kneading> Swedish> taping> Shiatsu> clapping> rolling> stop "
"Massage direction Press this button to change the massage mode, example "kneading mode 1> kneading mode 2".

9. Speed

The speed adjustment button for Swedish, Tapping, Shiatsu and Clapping – 5 level of speed to be adjust. After activating the Swedish, Tapping, Shiatsu or Clapping, every time this button was pressed, the speed can be adjust to “LV1> LV2> LV3> LV4> LV5 “ in cycle.

10. Full body Air Pressure massage

Press once to activate whole body air massage, press again to stop the function.

11. Manual Air massage

Setting Air sequence

Press this button to activate footrest air massage, press again cycle. the massage will switch to “Footrest> Hand> Shoulder> End” in a cycle.

12.Intensity

Air Intensity button – 5 level adjustment

In either auto or manual massage, press this button to adjust to air pressure “LV1>, LV2> LV3>, LV4>, LV5” in a cycle.

13.Waist heater

Waist heater control button

Press this button to activate the waist heater, press again to turn off.

14.Foot roller

Foot Roller button

Press this button to activate foot roller massage, press again to turn it off.

15.Incline / Recline

This two button is to adjust chair incline or recline position. When the desire angle was reach, press incline / recline button again to freeze it.

16.Zero G

Press this button to activate zero G angle, press again for “ZG1> ZG2> End” in a cycle.

End Operation

Please press the ON/OFF button after used, the chair as well the massage roller will back to the origin position then switch the power supply button under the chair to “O” and remove the plug from the socket.

The end of the massage

- Retract the foot massage part to the original position.
For security, be sure to put your legs away after used.

Caution

- Children are forbidden to use this machine.
In addition, children or pets are not allowed to play on the machine body, or climb up the legs, foot massage part, seat, backrest or armrest. Otherwise, it may cause accidents or injuries.

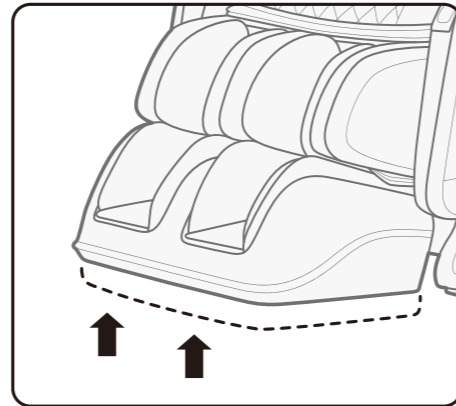

- Method to retract the legs massage part:

- Ensure there is nothing in the legs massage part
- Slowly remove the legs from the legs massage part
- Press the back lifting up key on the controller to retract the legs massage part to the original position.

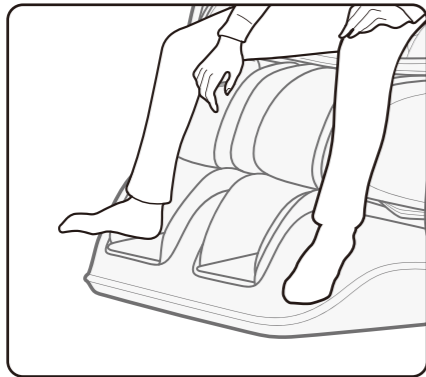

- Put the controller in the storage bag on the right side of the machine seat.

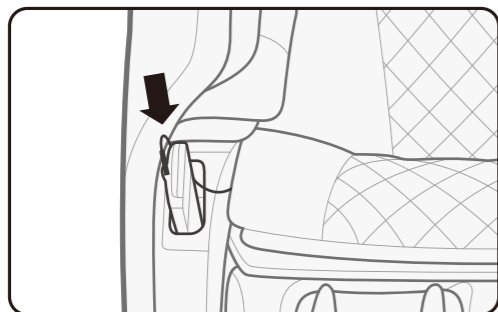

- Cut off the power.

Warning

- Every time when you finish the use of it, slide the power switch to the position "o" (off), and unplug the power plug. Otherwise, it may cause accident or injury due to child's mischief.

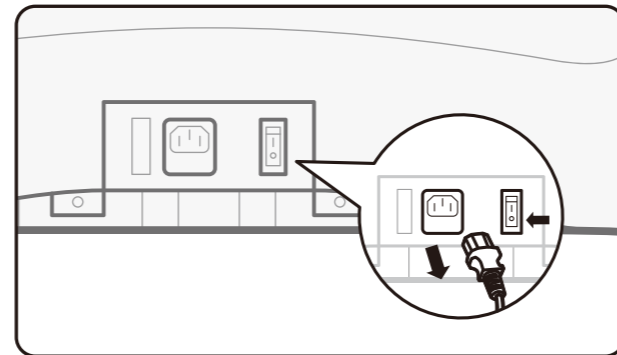

- Turn "off" the power switch.
- Unplug the power plug.

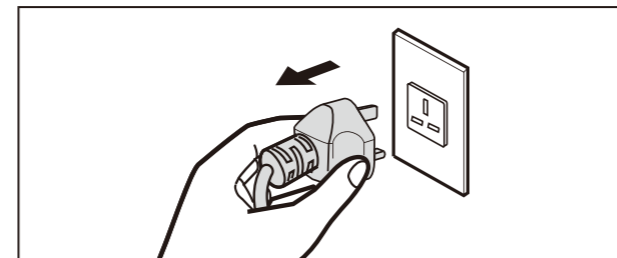

Cleaning and maintenance

Cleaning of the synthetic leather

Wipe the synthetic leather with a soft dry cloth.

- Do not clean the product with chemicals such as thinners, gasoline and alcohol.
- When using a leather maintenance product (cleaning cloth) sold on the market, follow its directions for use.
- If the synthetic leather is very dirty, wipe it with the method below.
 - Put a piece of soft cloth into water or 3% to 5% neutral detergent contained hot water and wring it out.
 - Wipe surface of the synthetic leather with the soft cloth
 - Wipe the detergent with a piece of cloth once soaked in clean water and wrung out.
 - Wipe with a piece of wrung soft cloth.
 - Have the synthetic leather take natural air drying.
- If it is difficult to remove the stains on the synthetic leather, soak a piece of melamine foam bought from the market into a neutral detergent and use it to wipe the product.
- Do not dry the surface by a hair drier.
- Surface of the synthetic leather may be dried by fabric colors; therefore, be careful when wiping the product with denim or colored cloth.
- Keep these positions from long-time contact with plastics to avoid fading.
- Synthetic leather may discolor, so the position in contact with the hair dye used should be covered by a towel.

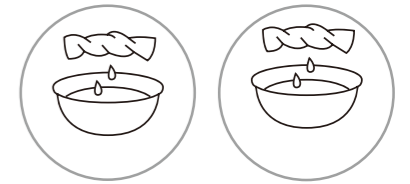

Cleaning of the plastic parts

- Put a piece of soft cloth into water or neutral detergent contained hot water, wring it out and wipe the plastic parts.

- Do not clean the product with chemicals such as thinners, gasoline and alcohol.

- Wipe with a piece of cloth once soaked in clean water and wrung out.

- Wring the cloth out before using it to wipe the remote controller.

- Have the plastic parts take natural air drying.

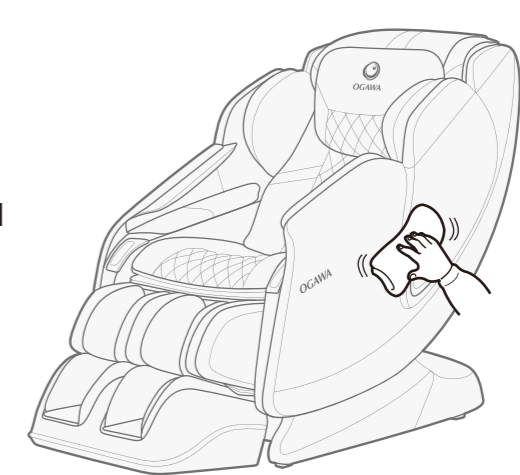

Questions and answers(Q&A)

Can persons paying frequent visits to hospitals because of diseases use the product?

These persons should consult physicians before using the product.

Massage is the so-called "touch-pressure stimulation": Muscles are compressed to relieve their tension and promote hemokinesis. Some diseases may get worsened because of massage. Thus, consult the attending doctors before using the product.

How about the body height requirement for use of the product?

The body height requirement differs with the specific body type. See the rough reference below when using the product.

If a person shorter than 145 centimeters or taller than 185 centimeters uses the upper body massage function and the Lower Leg/Foot massage function of the product at the same time, it will be possible that his soles will have poor contact with the foot massage section or that his knees will need to be bent.

For a taller person with knee bending when using the product:

Select method or below:

Tilt the backrest and lower the Lower Leg/Foot massage section
Massage the upper body only with the help of the footrest.
(Massage the feet and the upper body separately.)

For a short person difficult to touch the foot massage section:

Select method or below:

Raise the backrest and lift the Lower/Foot massage section.
Massage the upper body only with the help of the footrest.
(Massage the feet and the upper body separately.)

Are there any things needing special attention during moving?

Pay attention to the following things during moving.

For convenience during moving, tilt backrest of the product till the lowest position.
During handling, do not sit on the product.

Press ON button power on the product.

Press  to make the backrest completely tilt.

Press the button until backrest and footrest stop

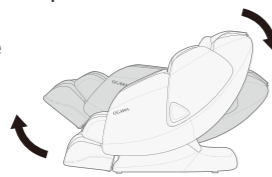

Turn off the power switch and pull out the power plug.

If the original packing box is available, make sure the power line is not wound on the product, wind it and place it on the seat surface. When handling the product, keep the power line from falling off and rubbing with ground.
If the original packing box is unavailable, properly keep other packing auxiliary materials and wrap the product with them to avoid scratch and vibration during handling.

Where is serial number of the product?

It is on back of the main body.

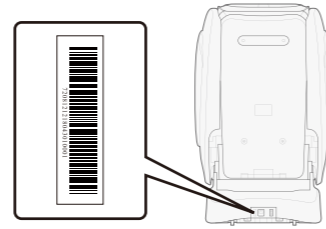

I care about the sounds of the product makes when being used.

It is caused by the core structure.

Does it matter if the massage wheels have different massage intensities?

This phenomenon possibly exists during massage because of the core structure.

To simulate the most natural massage effect, the product is designed with a core structure allowing alternate back massage by a left massage wheel and a right massage wheel. During massage, the massage wheels possibly have slightly different position on the back. That's why you have that feeling. It is not a fault.

The acupressure force is too large.

Set the air bag intensity to be "1" through the Air Bag button. You can also lower the Lower leg/Foot massage section to reduce the acupressure force on the feet.

How about monthly power consumption of the product?

Supposing you massage for 30 minutes in two times (15 minutes for each time) on each day, about 2.5 kilowatt-hours will be consumed each month.

Troubleshooting

After a fault happens, inspect and try the corresponding method below.

If the fault still exists after that, contact the shop from which you bought the product.

Fault	Cause and elimination method
The massage wheels stop during use (The product beeps and all icons and buttons on the remote controller flicker and then go out.)	For safety, the massage wheels will possibly stop upon a too large external force during use. If all marks and buttons on the remote controller begin to flicker, it suggests an extreme abnormality. In this case, turn off the power switch and turn it on about 10 seconds later. If the massage wheels stop again, adjust your sitting posture and do not lean on the backrest completely. (Users, particularly those heavier than 100 kilograms, should follow relevant precautions.)
The product cannot tilt, or the footrest can not be raised or lowered (The product beeps, the running light on the remote controller go out and the product stops)	For safety, the product will stop upon an obstruction or a too large force. If all contents and buttons are flickering and the backrest or the footrest has stopped, turn off the power supply and turn it on about 10 seconds later and then operate the product.
The massage wheels cannot reach the shoulders or the neck	If the head is not in contact with the headrest, or the back is not in contact with the backrest, the shoulder position in body type detection will possibly be lower than the actual position. Sit in the deepest position of the product, lean your head on the headrest and operate from the beginning again.
The left and right massage wheels have different heights (intensities)	It is not a fault but a normal phenomenon because the product is provide with a massage core allowing alternate beats of the massage wheels.
The product cannot run at all. ● Upper body (the neck to the waist) massage ● Lower leg/Foot massage	<ul style="list-style-type: none"> ● The power line is disconnected. ● The power switch is not turned on. ● No program is selected after ON button on the remote controller is pressed.
The product cannot cool down even if the temperature function is disabled	<ul style="list-style-type: none"> ● Due to the heater structure, the product will still feel warm shortly after heating because of the residual heat. ● If a single part is continually massaged even after the heating function is disabled, you will feel increasingly warmer.
The product is damaged	To avoid accidents, contact an authorized service center.
The power line or the power plug had abnormal heating	

Troubleshooting (continued)

The sounds and feelings you care about in use of the product.

You will hear or have the following sounds or feelings when using the product. It is not abnormal phenomena but results of the product structure.

- Sound when the stretching massage are retracted
- Sound and feeling when the massage wheels rub patterns on the fabric
- Sound of movements such as kneading and beat
- Friction sound of the running massage wheels
- Sound of up-down movement
- Sound of the conveyor belt
- Motor sound
- Sound of the squeezing massage wheels when they begin to stretch
- Sound when a person is sitting on the seat
- Friction sound between the armrests and the back cushion when the backrest is tilting
- Friction sound between the massage wheels and the fabric
- Sound of the inflator pump during Air Bag massage
- Sound of air exhaust during Air Bag massage
- Running sound of the solenoid valve at bottom of the product during Air Bag massage.
- Swing of the footrest
- Sound when the shoulders are stretched or moved
- Running sound of the air bags
- Sliding sound of the foot massage section
- Friction sound between the back cushion and the back cover leather when the backrest is tilting



If the sound is loud, it is also possible that the product has failed.

- In this case, have the product inspected and repaired by an authorized service center.

Warning

- **Do not refit, disassemble or repair the product without permission.** Otherwise fires, abnormal movements or personal injuries may happen.

Warning

- **In the case of any abnormality or fault, stop the product immediately and pull out the power plug to avoid fuming, fires and electric shocks.**
<Abnormality and fault examples>
 - The product fails to work after the power switch is turned to the ON position.
 - After the power line is moved, the product is discontinuously powered on;
 - In use, the product gives off a burning smell or an abnormal sound;
 - The product is deformed or abnormally heating
- In any of these abnormalities and faults, have the product inspected and repaired by an authorized service center immediately.

Specifications

Product Name	SMART RELUXE MASSAGE CHAIR
Model No.	OG6383
Rated Voltage	220-240V~
Rated Frequency	50-60Hz
Rated Power Consumption	65W
Timer	5/10/15/20/25/30 Minutes
Dimensions (L X W X H)	Upright: 1480x750x1080mm(L X W X H)
	Reclined: 1740x750x805mm(L X W X H)
Weight	Gross Weight: Approx. 101kgs
	Net Weight: Approx. 83.5kgs
Length of wire	Controller wire:90 Centimeter
	Power supply wire: 180 Centimeter
Usage condition	Environment temperature:10°C~40°C
	Contrasting humidity:30-85RH
Storage Condition	Storage temperature:20°C~60°C
	Storage humidity:30-85RH
Safety Feature	Equipped with overheated and power
The benefits of use	Improve blood circulation, relieve body tension

For a user heavier than 100 kilograms, the product may have bigger noise and its fabric housing may be worn quicker.

Contact Us



MALAYSIA
Healthy World Lifestyle Sdn Bhd
No. 22 Jalan Anggerik Mokara 31/47
Kota Kemuning, 40460 Shah Alam
Selangor Darul Ehsan, Malaysia
Tel : +603-5121 4286
Fax: +603-5121 4386



HONG KONG, CHINA
OGAWA Health Care International (HK) Ltd
31/F,YHC Tower,1Sheung Yuet Road
Kowloon Bay
Kowloon
Hong Kong
Tel:+852 3465 6262
Fax:+852 2410 0119



SINGAPORE
OGAWA Health-Care Pte Ltd
27 Tampines Industrial Avenue 5,
T5 @ Tampines
Singapore 528623

Tel:+065-6846 8588
Fax:+065-6846 7677



VIETNAM
OGAWA Vietnam Co Ltd
2nd floor,Petroland Tower,
12 Tan Trao,Tan Phu ward
District 7
Ho Chi Minh
Tel:+84 8 3775 3093/3775 3094
Fax:+84 8 3775 3095



INDONESIA
PT. CITRA PRATAMA MEDIKARYA
JL. Pangeran Jayakarta Komplek 20
Blok B No. 6. Mangga Dua Selatan.
Sawah Besar. Jakarta Pusat 10730,
Indonesia
Tel : (62) 21 6000722
Fax : (62) 21 6000731



PHILIPPINES
O-Healthcare Solution Phil. Inc.
2303, 4th Floor, G&A Building,
Chino Roces Avenue Extension,
Makati City, Philippines
Tel : +632 8889 0676/ +632 8844 6851
Fax: +632 8812 0421

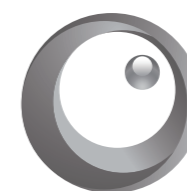

OGAWA

SMART RELUXE MASSAGE CHAIR

User manual
All information is correct at the time of print

目錄

使用前

- 重要的安全事項 01 - 04
- 接地說明 05
- 設置按摩椅 06 - 07
- 使用前 08 - 09
- 產品結構 10 - 12

使用方法

- 操作說明 13 - 16
- 按摩結束 17

維護

- 清洗及保養 18

Q&A/重要事項



- Q&A 19
- 故障檢修 20-21
- 規格 22
- 聯繫我們 23

重要的安全事項

必須遵守



下文列舉的是使用中為防止人身、財產損害而必須嚴格遵守的安全事項。





■ 所有安全事項將根據因錯誤使用而導致危害或損害的程度，予以說明。

 警告	可能造成重傷或死亡後果的事項內容。
 注意	可能造成輕傷或財產損害的事項內容。

■ 請注意各安全事項前的符號。（下文為符號範例）

 絕對禁止事項。	 必須執行事項。
---	---

 警告															
 必須遵守	<p>● 正在接受治療或有下列症狀的人，在使用本機前，應諮詢醫師。</p> <table border="0"> <tr> <td>(1) 佩戴起搏器或其他易受電子干擾的體內植入型電子醫療器械的人</td> <td>(8) 按摩部位受傷的人</td> </tr> <tr> <td>(2) 惡性腫瘤病人</td> <td>(9) 體溫在38°C以上（有發熱症狀）的人</td> </tr> <tr> <td>(3) 心臟病人</td> <td>(10) 必須靜養或身體顯著不適的人</td> </tr> <tr> <td>(4) 被查證喪失辨別溫度能力的人</td> <td>(11) 脊柱異常或脊柱彎曲的人</td> </tr> <tr> <td>(5) 孕婦或剛完成分娩的人</td> <td>(12) 患有椎間盤突出的人</td> </tr> <tr> <td>(6) 因糖尿病等高度末梢迴圈障礙引起知覺障礙的人</td> <td>(13) 除上述之外，身體感覺特別不適的人</td> </tr> <tr> <td>(7) 骨質疏鬆症患者、脊柱骨折病人、患有扭傷或肌肉拉傷等急性疼痛性疾病的人</td> <td></td> </tr> </table> <p>否則恐發生事故或造成身體不適。</p>	(1) 佩戴起搏器或其他易受電子干擾的體內植入型電子醫療器械的人	(8) 按摩部位受傷的人	(2) 惡性腫瘤病人	(9) 體溫在38°C以上（有發熱症狀）的人	(3) 心臟病人	(10) 必須靜養或身體顯著不適的人	(4) 被查證喪失辨別溫度能力的人	(11) 脊柱異常或脊柱彎曲的人	(5) 孕婦或剛完成分娩的人	(12) 患有椎間盤突出的人	(6) 因糖尿病等高度末梢迴圈障礙引起知覺障礙的人	(13) 除上述之外，身體感覺特別不適的人	(7) 骨質疏鬆症患者、脊柱骨折病人、患有扭傷或肌肉拉傷等急性疼痛性疾病的人	
	(1) 佩戴起搏器或其他易受電子干擾的體內植入型電子醫療器械的人	(8) 按摩部位受傷的人													
	(2) 惡性腫瘤病人	(9) 體溫在38°C以上（有發熱症狀）的人													
	(3) 心臟病人	(10) 必須靜養或身體顯著不適的人													
	(4) 被查證喪失辨別溫度能力的人	(11) 脊柱異常或脊柱彎曲的人													
	(5) 孕婦或剛完成分娩的人	(12) 患有椎間盤突出的人													
	(6) 因糖尿病等高度末梢迴圈障礙引起知覺障礙的人	(13) 除上述之外，身體感覺特別不適的人													
	(7) 骨質疏鬆症患者、脊柱骨折病人、患有扭傷或肌肉拉傷等急性疼痛性疾病的人														
	<p>● 使用中感到身體異常、或使用後覺得沒有效果時，請立即停止使用，並諮詢醫師。</p> <p>否則恐發生事故或造成身體不適</p>														
<p>● 按摩中或移動靠背、小腿、腳部按摩部件時，請事先確認本機周圍（本機後面、下面、前面和側面）沒有人或寵物。</p> <p>● 使用前請務必確認靠背和後蓋之間無異物或者寵物。</p> <p>否則恐發生事故或造成身體不適。</p>															
<p>● 在使用本機前，一定要掀開靠墊，以檢查靠背覆蓋在按摩輪活動範圍上的面料是否破損或者其他部位的面料是否披損。 （無論發現多麼細小的破損，都請立刻停止使用，拔掉電源插頭，並將本機報修。）</p> <p>在面料破損的情況下使用本機，可以引發受傷或觸電的危險。</p>															
<p>● 每次按摩請控制在30分鐘內。</p> <p>● 請將對身體同一部位的按摩控制在5分鐘內。</p> <p>否則可能出現負面效果並造成傷害。</p>															
<p>● 每次使用完畢，應將電源開關滑到“O”（關閉）位置，拔掉電源插頭。</p> <p>否則可能因兒童頑皮引發事故或造成傷害。</p>															
<p>● 請嚴格遵守插座和配線器具的使用規定。</p> <p>● 請使用220-240V~，50-60Hz交流電。 （請勿在國外使用本產品，或擅自連接變壓器。）</p> <p>否則可能引發觸電、機體故障或因過熱導致火災。</p>															
<p>● 請務必將電源插頭插到底，使其確實地插入插座中。</p> <p>否則可能引發觸電或因過熱導致火災。</p>															

 警告	
 必須遵守	<p>● 請定期清理電源插頭上的灰塵等髒污。 否則可能因濕氣等原因引發絕緣不良，從而導致火災。 （請用乾燥的抹布擦拭電源插頭。）</p>
	<p>● 發生異常、故障時，立即停止使用，拔掉電源插頭。（否則可能冒煙、起火、觸電） （異常、故障事例）</p> <ul style="list-style-type: none"> • 接通電源開關後可能不運作。 • 移動電源線後，有時通電有時不通電。 • 運行中發出焦臭味、異常聲響。 • 按摩椅變形或者異常發熱。 <p>→請立即委託授權服務中心檢查和修理。</p>
 禁止	<p>● 請勿將靠墊伸入靠背和後蓋之間。 否則可能會導致機體故障。</p>
	<p>● 請握住邊框進行本機搬運。 否則可能會導致機體故障或人身傷害。</p>
	<p>● 下列人員請勿使用本機。 被醫生禁止按摩的人（例：患有血栓症、重度動脈瘤、急性靜脈瘤、各種皮膚炎或皮膚感染症（包括患皮下組織炎症）的人等） 否則可能會導致病情惡化。</p>
	<p>● 下列人員請勿使用腰部按摩。</p> <ul style="list-style-type: none"> • 患有急性腰痛、椎間盤突出症、腰椎移位症的人 • 罹患變形性關節症等關節不適的人 <p>否則可能會導致病情惡化。</p>
	<p>● 在使用中請勿將手、手臂、腳塞入靠背覆蓋在按摩輪活動範圍上的面料。</p> <p>● 兒童禁止使用本機。此外，請勿讓兒童在本機上玩耍，或者爬到小腿、腳部按摩部、座面、靠背或扶手上。</p> <p>● 請勿攀爬靠背或者扶手。</p> <p>● 請勿倚靠或坐在靠背上。</p> <p>● 請勿將頭伸入靠背和後蓋之間的活動區域。</p> <p>● 請勿讓不能表達自己意思的人或沒有能力操作本機的人使用本機。</p> <p>● 按摩頸部時，請注意按摩輪的動向，請勿按摩前頸，請避免過重地按摩頸部。 否則可能會引起事故或造成傷害。</p>
	<p>● 請勿損壞電源線及電源插頭 （請避免此類行為：損傷、加工、強行彎曲、扭轉、拉長電源線及電源插頭，或將電源線及電源插頭靠近發熱器，或在電源線及電源插頭上系重物、或任意捆綁。） 使用破損的電源線或電源插頭，可能引起觸電、短路或引發火災，請到購買本產品的商店或指定的維修中心諮詢修理電源線或電源插頭的方法。</p>
	<p>● 請勿長時間使用“腰部溫熱”按摩。 可能出現低溫燙傷。 即使溫度相對較低（40°C~60°C），長時間接觸皮膚的同一部位沒有發熱、疼痛等自覺症狀，也可能導致低溫燙傷。</p>
	<p>● 請勿損壞膝蓋部溫熱（加熱器）。</p> <ul style="list-style-type: none"> • 不要將別針、針扎進本機。 • 不要用刀具損傷。 <p>損傷內部加熱器可能導致火災或者觸電事故。</p>
 濕手禁止	<p>● 請勿用沾濕的手插、拔電源插頭。 否則可能導致觸電事故。</p>
 分解禁止	<p>● 請勿擅自改造本機。請勿自行分解或修理本機。 否則可能導致起火、異常動作、人身傷害。</p>

⚠ 注意

- 下列人員即使目前身體健康，也請諮詢醫師後再使用本機。
(1) 因年齡增長而導致肌肉萎縮的人或身體纖瘦的人 (2) 因骨頭或內臟問題而感覺腰痛的人
(3) 容易扭傷或容易瘀傷的人 (4) 暈車、暈船或乘坐其他交通工具時，反應異常激烈的人
(5) 過去曾被施予心臟手術或其它內臟手術的人

否則可能有損自身健康。

- 就坐前，請先確認本機各個部件之間沒有異物。
(確認後蓋、靠背、座面、小腿·腳部按摩部、靠墊內側沒有夾雜異物。)

否則可能因手、腳或其他物品被本機夾住，而引發事故、造成傷害或機體故障。

- 頭部佩戴任何硬質飾物（如髮夾等）時請勿使用本機。
- 當褲子口袋內部有硬物時（如手機、鑰匙等），將其取出，然後按摩。
- 按摩手、手臂時，取下手錶、指甲套、戒指等。

否則可能導致傷害。

- 就座前，確認按摩輪處在收納位置。
- 按摩途中若想離開座位，必須先停止按摩椅運作，再離開座位。

否則可能引發事故或造成傷害。

- 請勿扯電源線試圖拔出電源插頭，一定要握住插頭本身將其拔出。

否則可能引發觸電或短路。

- 移動本機前，必須把小腿·腳部按摩部的角度調節回最初位置。

否則可能造成傷害。

- 如果使用滑輪滾動本機，請在地板上墊上墊子等。

否則可能在地板上留下傷痕。

- 請勿讓兒童使用遙控器托架的固定螺絲。

否則可能因兒童誤食或頑皮引發事故或造成傷害。

- 使用滑輪移動本機前，須先清空周圍障礙物。抬起小腿·腳部按摩部座面到略低於腰的位置，慢慢移動。

否則可能因機身翻倒引發事故或造成傷害。

- 須將本機放置在水平面上使用。

否則可能因機身翻倒引發事故。

- 因使用本產品而產生出疹、紅腫、發癢等症狀時，請立即停止使用，並諮詢醫師。

否則可能引發事故或導致身體不適。

- 閒置一段時間後使用本品，請先重新閱讀一遍產品使用說明書，並確認機體運作正常後，再開始使用。

否則可能引發事故或造成傷害。

- 請勿和其他器械同時使用。

否則可能造成事故或引起身體不適。

- 請勿將頭部、腹部或皮膚緊貼按摩輪。此外，請勿將手或腳伸入按摩輪之間。
- 請勿將膝蓋夾在小腿和腳部按摩部之間。
- 勿在使用本機時入睡。此外，飲酒後請勿使用本機。
- 當鼓起的座面氣囊裡的空氣沒有被排放完時，不要站在座面上，或者跳上去，或者在上面放東西。

否則可能導致事故、傷害。



必須遵守



禁止

⚠ 注意

- 請勿將手或腳伸入本機與小腿·腳部按摩部之間。
- 請勿將手、手臂或頭伸入小腿腳部按摩部（腳置臺）的縫隙間。
安全起見，結束按摩後，請一定要收納好小腿·腳部按摩部。
- 請勿將手、手臂或頭伸入靠背和後蓋之間。
- 請勿將寵物放在按摩椅上（後蓋、靠背、扶手等）。
- 按摩中，請勿突然拔出電源插頭、或突然關閉電源開關。

否則可能造成傷害。

- 請勿站立或坐在後蓋上。

否則可能導致本機翻倒，造成人身傷害。

- 請勿站立或坐在扶手上。

否則可能導致人身傷害。

- 請勿站立或坐在小腿·腳部按摩部及腳置臺上。
否則腳置臺前部旋轉或本機傾倒可能導致事故、傷害。

小腿·腳部按摩部底部撞到地板時，可能損壞地板。

- 請勿在已安裝好的狀態下托動或推動本機。

否則可能損壞地板。

- 請勿在有人入座時移動本機。

否則可能因機身翻倒引發事故或造成傷害。

- 請勿在電熱毯等加熱設備上使用本機。

否則可能引起火災。

- 請勿將遙控器放置在座面上。

否則可能損壞本機。



禁止濕手觸碰



禁止沾濕

- 請勿在浴室或其他潮濕的地方使用本機。

否則可能引發觸電或機體故障。

- 請勿將水滴等物質撒在本機或遙控器上。

否則可能引發觸電、短路或引起機體故障。



拔出電源插頭

- 清洗及保養本機，必須先從插座上拔出電源插頭。

否則可能引發觸電或造成傷害。

- 停電時立刻拔出電源插頭。

否則可能在恢復供電時導致事故、傷害。

- 不用時，一定要從插座上拔出電源插頭。

否則灰塵、濕氣可能導致絕緣老化，引發漏電火災。

接地說明

- 本機必須接地。如果本機發生功能故障，可以使用接地來減少觸電危險。
- 本機裝備了具有接地導線和接地插頭的電源線。必須將該插頭插入已完全依照當地代碼和法令進行正確安裝和接地的、合適的插座。

⚠ 注意

- 若設備接地導線的連接不當，則會導致觸電危險。如果您對本機的接地是否正確存有疑問，請委託專業電工進行檢查。即使本機附帶的插頭與插座不配，也不能對其進行改造。請委託專業電工安裝合適的插座。
- 本機具有接地插頭。請確認本機連接至具有與插頭形狀匹配的插座。
- 本機不能使用轉接插座。
- 如果電源線損壞，必須使用專用的電源線或從其製造商或維修部買專用元件來更換。
- 本產品具有發熱表面，對熱不敏感的人使用時必須注意

設置按摩椅

1 安裝位置

確保足夠空間以便按摩椅可以傾斜。

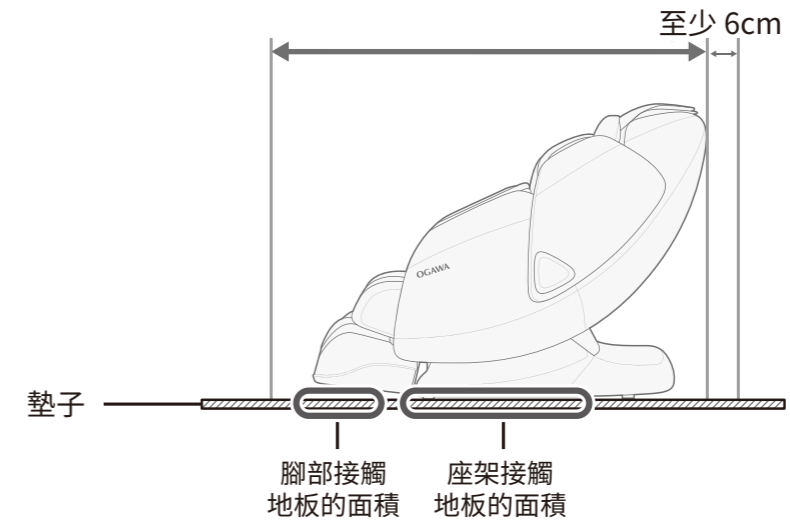

- 請勿將按摩椅暴露於陽光直射或高溫環境下（如加熱設備前），因為這樣可能導致按摩椅合成皮革褪色或硬化。
- 為避免地板損傷，請在本機下鋪上墊子。平鋪墊子時，墊子的大小應足以蓋住本機接觸地板的範圍與腿置台接觸地板的範圍（至少200cmX90cm），如圖所示。
- 安裝本機時應靠近電源插座。

2 產品移動說明

方法一：托住座架底部兩側，然後抬起並移動。



- 由於本機較重，因此搬運時請小心，以免造成背部拉傷。（本機必須由兩人或多人搬運。）

本機重量

約83.5kg

※注意※

- 1、在木地板等易損的地面上請抬起側板進行移動。
- 2、請將手伸入座架底部托住鋼架再抬起，以免座架外側塑料件損壞。

將本機放置在地板上

- 緩慢地放下本機，小心腳部被壓傷。
- 直到機身完全放平前，請勿放開腳置臺。突然鬆手，將導致腳置臺彈回最初位置。
- 地板可能受損，因此，建議在地板上鋪上墊子等物料。

⚠ 注意

- 請勿在未安裝好的狀態下托動或推動本機。
- 請勿握住側板或座架外側塑料件進行搬動。否則容易導致本機故障或人身傷害。
- 如需在使用後腳輪移動本機，建議在移動位置下方鋪上墊子，以免地板劃傷。
- 請勿在有人入座時移動本機。否則可能因跌倒導致本機故障或人身傷害。
- 移動本機前請關機並確認靠背與腳部完全復位。否則可能導致本機故障或人身傷害。

方法二：使用後腳輪移動按摩椅。

⚠ 注意

如果使用後腳輪移動本機，請在地板上墊上墊子，否則可能在地板上留下劃痕。

- 1 按下“開/關”按鈕，關閉所有功能。
- 2 將本機靠背和腿部復位到原始位置。將本機後下方電源開關按到“O”（關閉）位置，拔下電源插頭。

- 按圖示方式，將椅子向下後方傾倒約45度進行移動。

注意：下壓幅度請勿太大，避免椅子完全傾倒導致頭罩損壞。

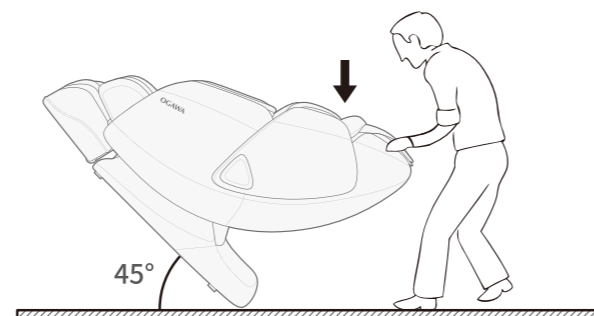

使用前

1 檢查周圍

確定本機周圍沒有人、寵物及其他物體。

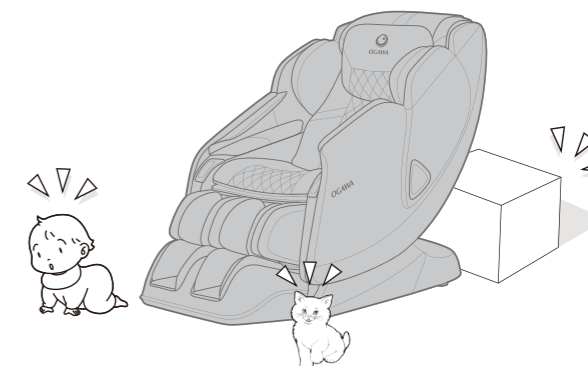

2 確保本機縫隙間沒有異物

按摩前請確認小腿、腳部等位置沒有夾住異物。

⚠ 注意

- 不要將手、手指、腳、頭伸進小腿與座部、扶手的間隙內。
- 入座前，請先確認本機各個部位之間沒有異物。
- 請勿將手、手臂或頭深入靠背與後蓋之間。
- 請勿將寵物放在按摩椅上(座部、靠背、扶手、腿部等位置)。

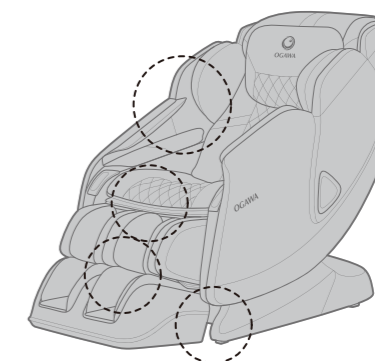

3 打開電源

按摩前請確認小腿、腳部等位置沒有夾住異物。

1. 將電源插頭插入電源插座。

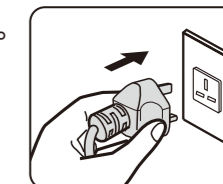

2. 將本機後下方電源開關按到“1”（開啟）位置。

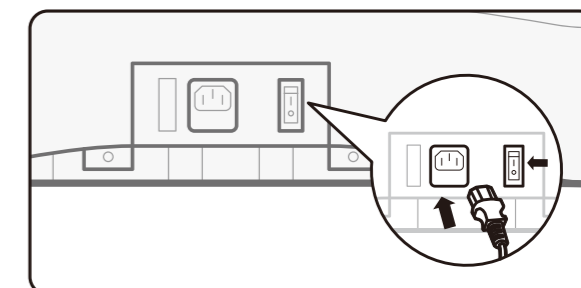

⚠ 警告

- 使用前請檢查電源線及電源插頭是否損壞。
- 入座前，請先確認本機各個部位之間沒有異物。請務必將電源插頭插到底。否則可能引發觸電或過熱導致火災。
- 請使用220-240V~ 50-60Hz交流電。請勿在國外使用本產品、或擅自連接變壓器。否則可能引發觸電、機體故障或過熱導致火災。
- 請勿用沾濕的手插、拔電源插頭。

使用前

4 檢查確認按摩輪處於收納位置

按摩輪未處於收納位置時，按下“開/關”按鍵返回收納位置。



按下“開/關”按鍵返回收納位置。



5 確認面料未破損存在裂縫

重點檢查區域：靠背覆蓋在按摩輪活動範圍上的面料。

⚠ 注意

- 在使用本機前，一定要掀開靠墊，檢查圖示的重點區域面料是否破損。其他部位也要確認面料是否破損。(無論發現多麼細小的破損，都請立刻停止使用，拔掉電源插頭，並將本機送修。在面料破損的情況下使用本機，可能引發傷害或觸電的危險。)

重點檢查區域

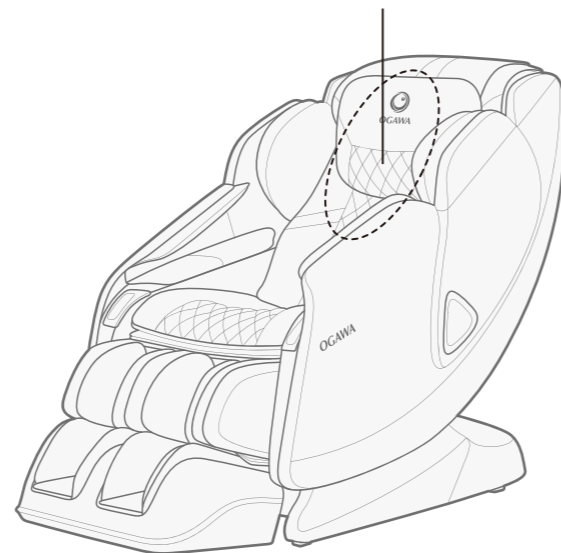

產品結構

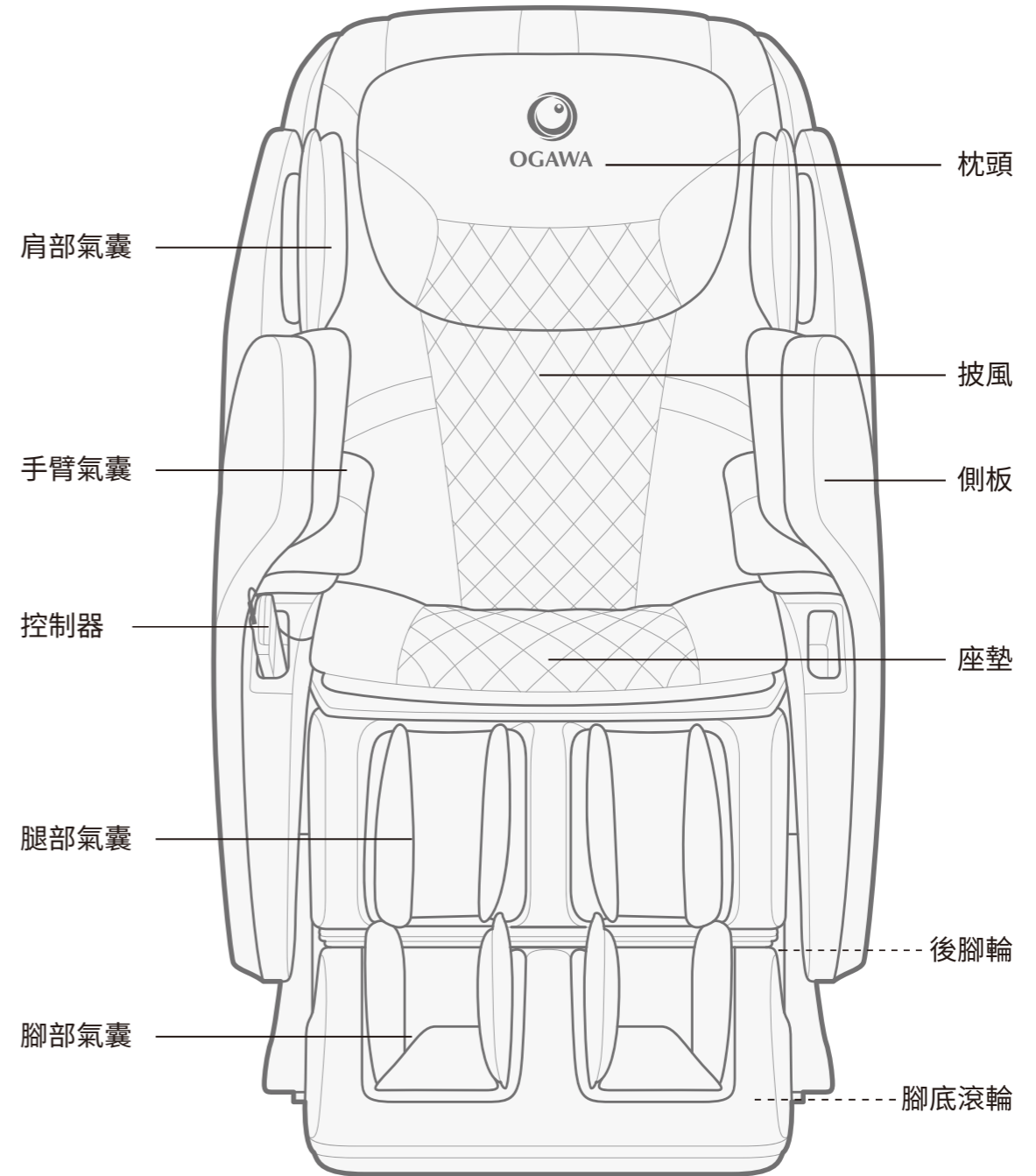

產品結構

功能分佈示意

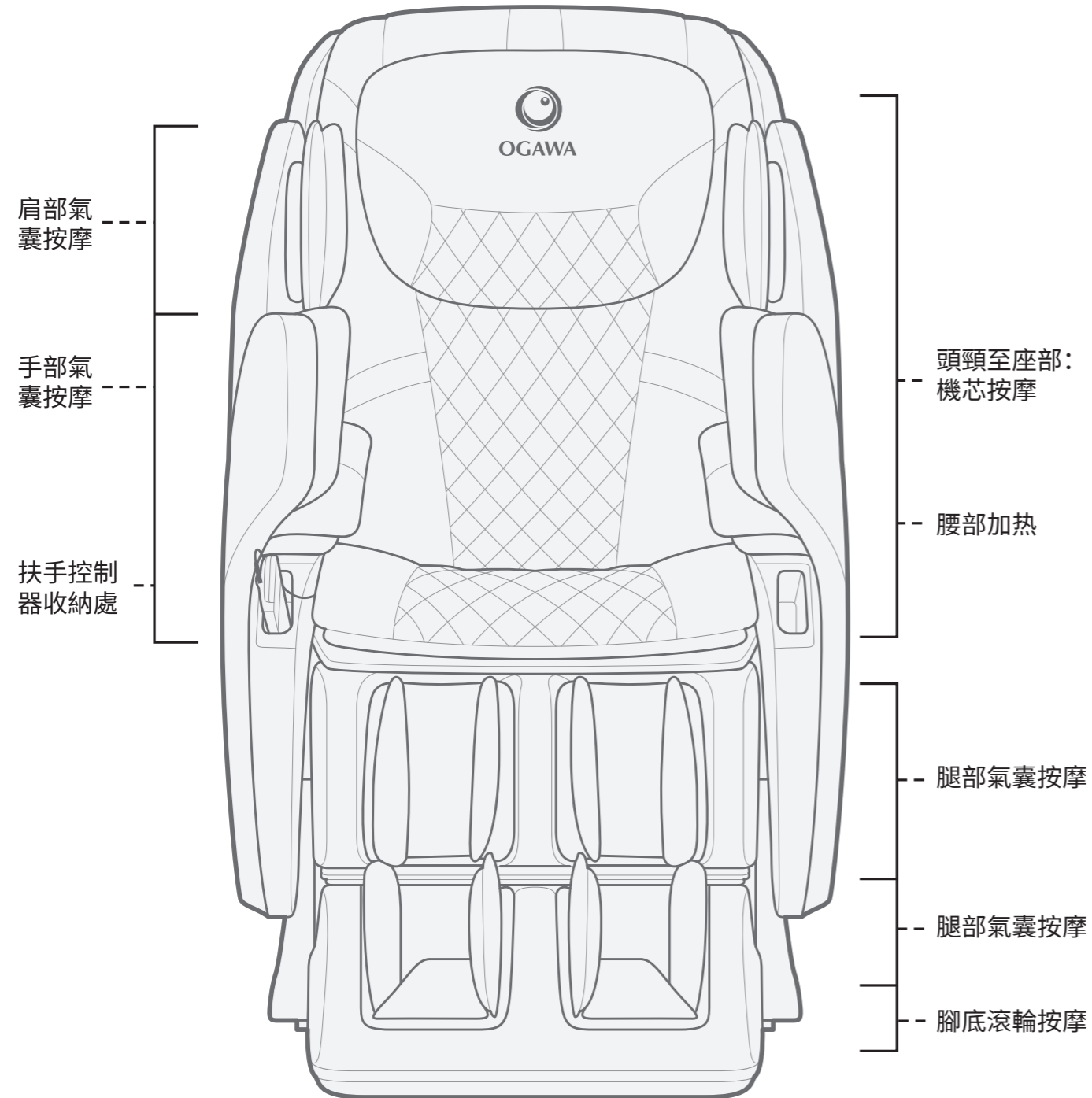

產品結構

控制器

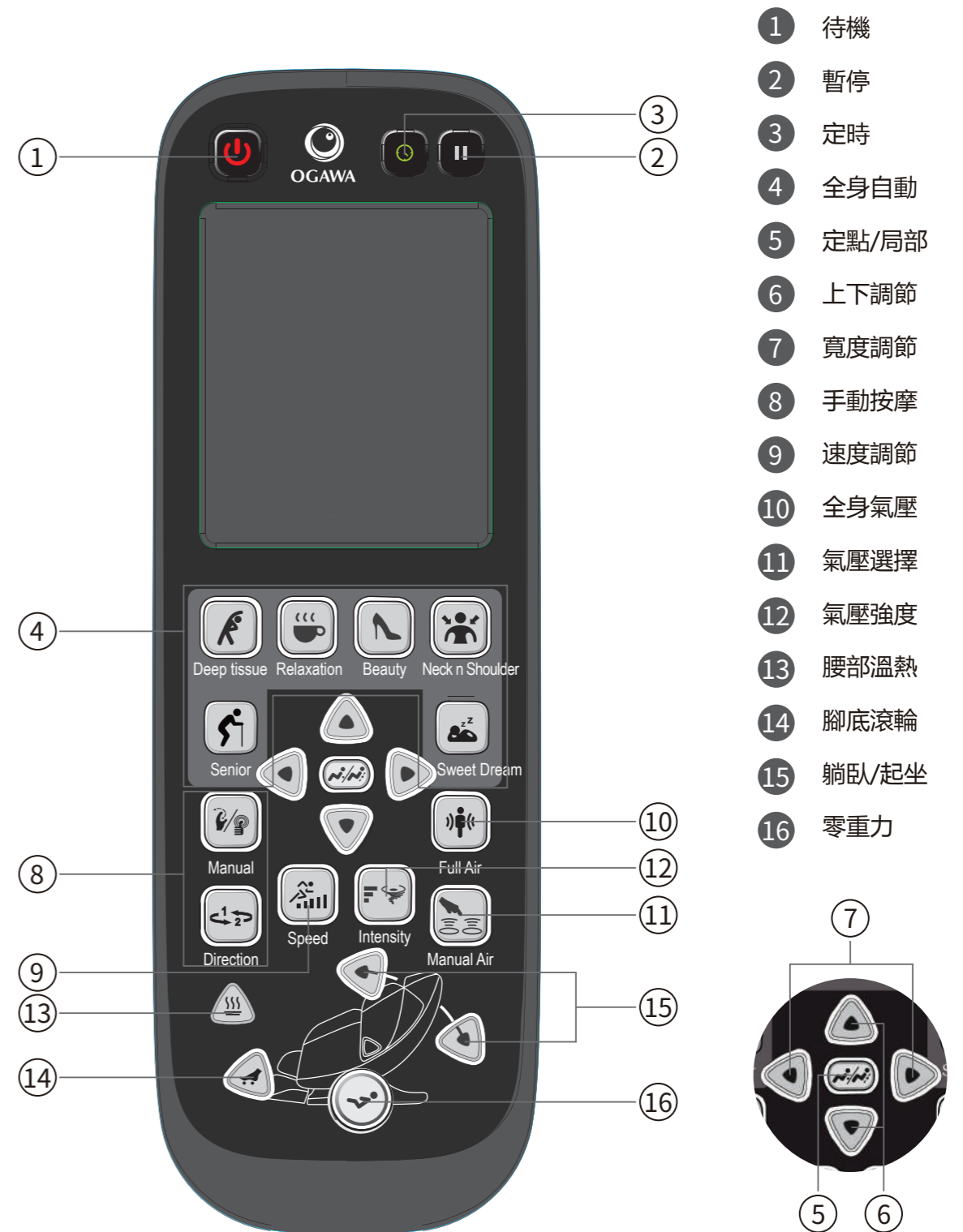

操作說明

一、使用本產品請注意如下事項：

- 1、接通電源，將按摩椅座架下方的電源開關按至“I”的位置，按摩椅處於復位狀態。此時按摩椅進入待機狀態，在待機狀態下，開/關控制鍵的紅燈會不停的閃爍，表示已接通電源。
- 2、在待機狀態的情況下，只有開關、暫停、升背、倒背及零重力五項功能可以操作。

二、按摩椅控制鍵

1、待機鍵

整機按摩功能啟/停控制鍵

按一下此控制鍵開機，手控器的紅色燈和手控器螢幕將被點亮，此時按下任何鍵開始享受按摩，同時將啟動定時功能。產品處於運行狀態時按一下此鍵關機，按摩輪、靠背和小腿將恢復到初始位置。

2、暫停

暫停控制鍵

如需暫停按摩功能，請按暫停鍵，此時所有按摩功能都將停止。暫停控制鍵的橙色燈將會閃爍，定時功能也一併暫停。再按此控制鍵以繼續被暫停的按摩功能，定時功能也將恢復計時。

3、定時

按摩時間控制鍵

當按摩功能啟動時，定時功能時間預設為15分鐘，每按一次此控制鍵，定時時間段將按“20>25>30>5>10>15>20”分鐘迴圈。定時時間段將按“20>25>30>5>10>15>20”分鐘迴圈。

4、全身自動按摩功能

當6個自動按摩程式中任意一個啟動之後，產品對背部自動進行檢測以達到最佳的按摩位置。同時也可根據需要按上、下方向鍵對按摩位置進行手動調整。

6個部自動按摩程式：

Deep tissue
Relaxation
Beauty
Neck n Shoulder
Senior
Sweet Dream

5、定點/局部

背部定點功能控制鍵

此鍵用於啟停背部定點按摩功能。在所需按摩的位置按一下此鍵將對該按摩位置提供集中的定點按摩。再按一下則解除“定點”按摩功能。

背局部功能控制鍵

在所需按摩的位置按一下此鍵，開啟背部區間按摩功能。則在原點上下8CM的區間內提供背部局部按摩，再按一下此鍵則解除背部“局部”按摩功能。

6、上下調節

定點和局部功能位置調節控制鍵

在定點/局部按摩時，長按向上或向下方向鍵可調節按摩輪位置，到需要的按摩位置時放開，由此可以根據需要調節按摩位置。
注：開啟自動程式，對肩部進行檢測後，如需要調整肩高度，可在檢測後10秒內按此二鍵進行微調。

7、寬度調節

錘擊、指壓、拍打和推拿寬度控制鍵

在捶打、指壓、拍打和推拿按摩啟動時，按向左鍵，寬度變窄，反之變寬。

8、手動按摩功能

手法切換

按一次此控制鍵啟動全背部揉捏按摩功能，每按一次此控制鍵將按順序切換“揉捏 > 瑞典式 > 捶擊 > 指壓 > 拍打 > 推拿 > 停止”按摩手法。

模式切換

選擇好按摩手法後，可進行模式切換，如選擇“揉捏”時，將進行“揉捏1”模式按摩，此時按下此鍵則切換到“揉捏2”模式，依此類推。

9、速度調節

揉捏，瑞典式，捶擊，指壓及拍打按摩功能的速度調節控制鍵 - 5檔速度可調在揉捏，瑞典式，捶擊，指壓及拍打按摩功能運行模式下，每按一次此控制鍵將對按摩速度如“Lv1 > Lv2 > Lv3 > Lv4 > Lv5”進行迴圈調整。

10、全身氣壓按摩

全身氣壓按摩啟停控制鍵

按一次此鍵，全身充氣按摩，再按一次則停止全身氣壓按摩功能。

11、氣壓選擇

充氣部位選擇控制鍵

按一次此鍵，進行小腿充氣按摩，每按一次此控制鍵將按順序切換“腿腳部 > 手部 > 肩部 > 停止”充氣部位。

12、氣壓強度

氣壓按摩強度控制鍵 - 5檔強度可調

在自動或手動氣壓按摩模式下，每按一次此控制鍵將對氣壓按摩強度如“Lv1 > Lv2 > Lv3 > Lv4 > Lv5”進行迴圈調整。

13、腰部溫熱

腰部溫熱功能啟停控制鍵

按一次此鍵開啟腰部溫熱功能；在開啟溫熱狀態下，按一下，則停止此功能。

14、腳底滾輪

腳底滾輪功能啟停控制鍵

按一次此鍵，開啟腳底滾輪按摩功能，再按一次，則停止此功能。

15、躺臥/起坐

按摩角度調節控制鍵

此二功能控制鍵可調節躺臥/起坐角度。按一次躺臥或起坐功能控制鍵以進行按摩角度調節。當按摩椅到達適當的角度時，再按一次躺臥、起坐中的其中一個控制鍵即可定位。

16、零重力

按一次此鍵啟動零重力1形態，再按一次此鍵將進行改變至零重力2形態，再按此鍵則關閉零重力功能。

操作完成

使用完畢之後，請按下“開/關”鍵，按摩椅將停止動作，按摩滾輪將自動復位。復位完成後，請按下按摩椅下方的電源開關至“O”的位置，接著可以安全拔出電源線。

按摩結束

- 1 將腳部按摩部收回最初的位置。**
為確保安全，使用完畢後，請務必收起腿部。

注意

- 兒童禁止使用本機。
此外，請勿讓兒童或寵物在本體上玩耍，或者爬到小腿·腳部按摩部、座部、靠背或扶手上。否則可能會引起事故或造成傷害。

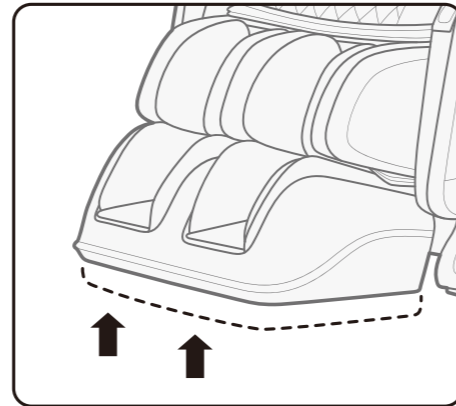

- 2 腿部按摩部的收回方法：**

- 確認腿部按摩部內沒有任何物品
- 慢慢地將腿從腿部按摩部上移開
- 按控制器上升背鍵，將腿部按摩部收回原點。

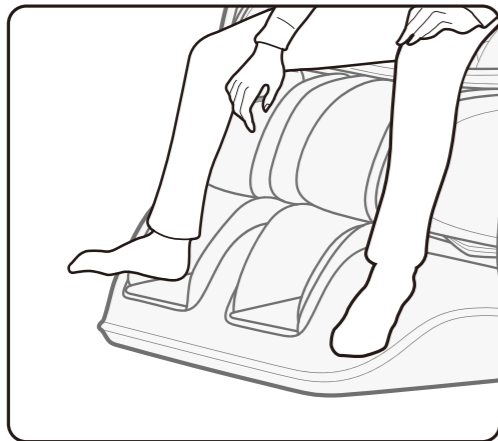

- 3 將控制器收入本機座部右側收納袋內。**

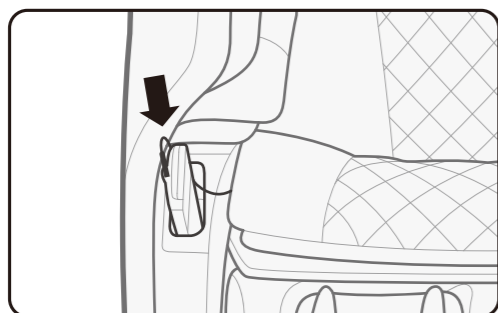

- 4 切斷電源。**

警告

- 每次使用完畢，應將電源開關滑到“0”（關閉）位置，拔掉電源插頭。
否則可能因兒童頑皮引發事故或造成傷害。

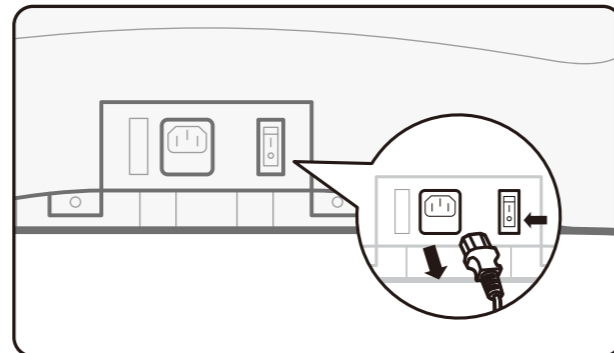

- 1、“關閉”電源開關。
- 2、拔下電源插頭。

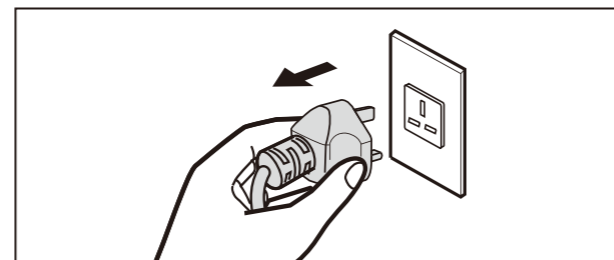

清洗及保養

清潔合成皮革部分

使用柔軟的幹布擦拭皮革。

- 切勿使用諸如稀釋劑、汽油、酒精等化學品清潔本機。
- 使用市面銷售的皮革保養品（抹布）時，請遵照其使用說明。
- 如果合成皮革特別髒，則通過以下方式擦拭。
 - ①將軟布浸入水中或含3%至5%中性洗滌劑的熱水中，然後徹底擰乾。
 - ②使用上述軟布擦拭皮革表面。
 - ③使用浸過清水且已徹底擰乾的布料擦掉清潔液。
 - ④使用擰乾的軟布擦拭。
 - ⑤使其自然風乾。
- 難以去除汙漬時，請將市面上購買的三聚氰胺泡棉浸入中性洗劑中，然後且它擦拭本機。
- 不要使用吹風機吹幹表面。
- 由於布料的顏色會染到合成皮革的表面上，因此在使用牛仔布和彩色布料擦拭本機時務必小心。
- 不要使這些部位長時間與塑膠接觸，因為這會導致褪色。
- 合成皮革有變色的可能，所以在使用染髮劑時，請將接觸的部分用毛巾覆蓋。

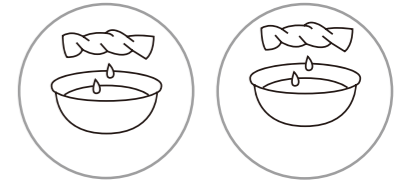

- 1 將軟布浸入水中或含有中性洗滌劑的熱水中，擰乾後，擦拭本機塑膠部。**

- 切勿使用諸如稀釋劑、汽油、酒精等化學品清潔本機。

- 2 使用浸有清水且已徹底擰乾的布料擦拭。**

- 擦拭遙控器前請務必擰乾布料。

- 3 使其自然風乾。**

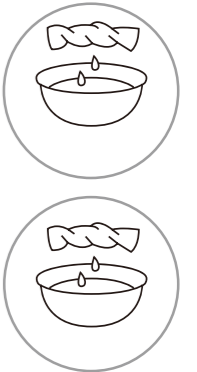
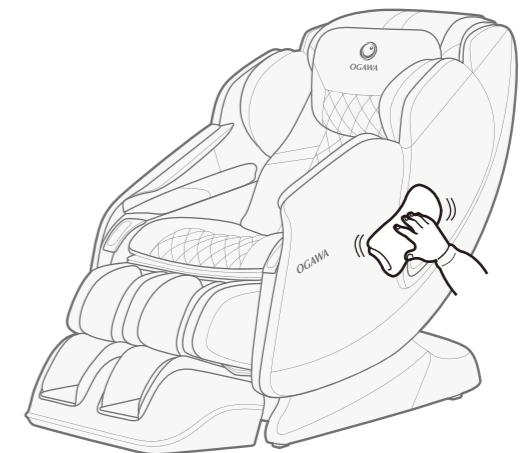

疑問解答 (Q&A)

Q 因為生病而經常出入醫院的人可以使用本品嗎？

A 經常出入醫院的人，請在與醫生商量的前提下使用本品。

按摩即所謂“觸壓刺激”，即通過對肌肉進行壓迫，緩解肌肉緊張，促進血液流動。根據不同的病因，按摩有可能造成病情惡化，因此請務必在和主治醫生商量之後使用本品。

Q 身高多少的人適合使用本品？

A 根據體型的不同多少會有所差異，請大致參考下文使用本品。

- 身高小於145cm的用戶，及身高超過185cm的用戶同時使用上半身按摩和小腿、腳部按摩時，可能出現足底與腳部按摩部接觸不充分，或膝蓋彎曲的情況。

身高較高的用戶感覺膝蓋部位彎曲時

請選用下述方法 **A** 或方法 **B**

- A** 放倒靠背，降低小腿、腳部按摩部位置。
- B** 利用腳置台，只對上半身進行按摩。
(足部按摩與上半身按摩分開使用)

身高較矮的用戶難以向下觸到足底按摩時

請選用下述方法 **A** 或方法 **B**

- A** 抬起靠背，升高小腿、腳部按摩部位置。
- B** 利用腿置台，只對上半身進行按摩。
(足部按摩與上半身按摩分開使用)

Q 搬家時，有什麼需要特別注意的地方？

A 請注意以下事項。

- 為了方便搬運，請先將按摩椅靠背傾斜到最低位置。
- 搬運時，人不要坐在座椅上。

① 按下開機鍵，接通電源。

② 按下使  靠背呈完全傾斜狀態。

再按下此按鈕靠背和小腿停止移動。





③ 關閉電源開關，拔出電源插頭。

- 在有原紙箱的情況下，請先確認電源線未被纏繞在本機上，將電源線好放在座面上，搬運的時間請注意電源線沒有掉落且未與地面發生摩擦。
- 在沒有原裝紙箱的情況下，為了防止機體劃傷和搬運中的震動，請妥善使用其它包裝輔材包裹本品。

Q 請問在哪裡可以看到產品的製造編號？

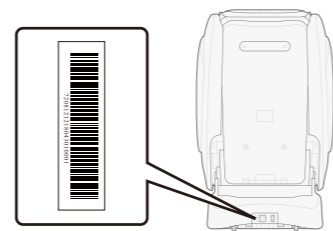
A 經在按摩椅主體背面的座面下。



Q 有點在意按摩椅運作時發出的聲音 

A 按摩椅運作時產生的聲音，一般是由於機芯構造而發出的。

Q 按摩中感覺左右兩邊按摩輪的按摩力度有差異，要緊嗎？

A 由於機芯構造，在按摩過程中，確有可能感覺左右按摩輪的力度有差異。

為了能夠模擬出最自然的按摩手法，本品機芯採用了允許左右按摩輪交替捶背的機芯構造。在按摩過程中，左右按摩輪接觸背部的具體位置可能稍有差異，從而導致了使用者產生左右兩側按摩力度有所不同的感覺。此時，本品本身並未發生故障。

Q 感到足底指壓過於用力 

A 使用氣囊按鈕將氣囊強度設置為最弱檔。另外，降低小腿、腳部按摩部，也可以減輕足底的指壓力度。

Q 使用本品時每個月耗電量是多少？

A 按每日30分鐘，使用頻率來計算，每月本品耗電量約為2.5度。

故障檢修

發生故障後，首先檢查並嘗試以下方法。

如果有嘗試後，故障依然存在，請聯繫銷售店。

問題	原因和處理方法
<p>在使用本機過程中按摩輪停止 (按摩椅發出“嗶嗶”的聲音，遙控器上所有的顯示圖示和按鈕閃爍，然後熄滅)</p>	<p>在使用過程中，按摩輪遇到過大的外力時，出於安全考慮，按摩輪可能會這止移動。</p> <p>如果遙控器上的所有標記和按鈕開始閃爍，這種情況極為異常，請關閉電源開關，等待約10秒鐘，然後再次打開電源。如果按摩輪再次停止，請調整自己的坐姿，不要使背部完全貼在靠背上。(應注意遵守相關注意事項，尤其是體重在100kg或以上的人使用時。)</p>
<p>不能傾斜 小腿不能升高降低 (發生“嗶嗶”的聲音，遙控器的運行指示燈熄滅並停止運行)</p>	<p>如果本機遇到了障礙物或者在使用本機時用力過大，出於安全考慮，本機將停止工作。</p> <p>當所有顯示的內容及按鈕在閃爍時，且靠背或小腿已停止工作。關閉本機電源一次，約10秒鐘後再次打“開啟”電源，然後操作本機。</p>
<p>按摩輪沒有達到肩部或頸部的位置</p>	<p>如果頭部沒有接觸到靠枕，或背部沒有接觸到靠背，在體型檢測過程中肩部位置可能低於實際位置。坐在座椅的最深位置，將頭部靠在靠枕上，然後從頭開始重新操作。</p>
<p>左右按摩輪的高度(強度)不同</p>	<p>因為搭載了可進行按摩輪交互捶拍動作的按摩機芯，出現這種情況純屬自然，並非機體故障。</p>
<p>本機根本無法運行</p> <ul style="list-style-type: none"> ● 上半身(頸部至腰部)按摩 ● 小腿和腳部按摩 	<ul style="list-style-type: none"> ● 電源線連接已斷開。 ● 沒有打開本機電源開關。 ● 按下遙控器上的開機鍵按鈕後，沒有選擇任何程式。
<p>即使關閉溫熱功能，溫度也降不下來</p>	<ul style="list-style-type: none"> ● 由於加熱器的結構，加熱後片刻依然會因為餘熱而感到溫暖。 ● 即使關閉溫熱功能，持續按摩同一部位，也會使體感溫度上升。
<p>本機已受損</p>	<p>為防止事故發生，請務必與授權服務中心聯繫。</p>
<p>電源線或電源插頭異常發熱</p>	

故障檢修 (續)

關於運行過程中本機發出的聲音和令人在意的感覺

在使用中會發生下述動作音、感覺，不過這是因按摩椅的結構而發生的，並非異常。

- 按摩輪由“伸出”改為“收回”時的聲音
- 動作時按摩輪擦過面料上的皺紋時發出的聲音和感覺
- 揉按、捶拍動作等的動作音
- 按摩輪動作時的摩擦聲
- 上下動作時的動作音
- 傳送帶的轉動音
- 電機音
- 按摩輪從“擠壓”改為“拉伸”時的聲音
- 落座時的聲音
- 靠背傾斜時扶手與靠墊的摩擦聲
- 按摩輪與布料的摩擦聲
- 氣囊按摩運作時的充氣泵工作音
- 氣囊按摩運作時的排氣音
- 氣囊按摩運作時座椅下電磁閥發出的工作音
- 腳置台的晃動
- 肩部伸展、動作時的聲音
- 氣囊的動作音
- 腳部按摩部的滑動音
- 靠背傾斜時，靠墊與後蓋上皮革摩擦時發出的聲音



當聲音變大時，也有可能發生了故障。

- 此時，請委託授權服務中心進行檢查和修理。

警告

- 請勿擅自改造本機。請勿自行分解或修理本機。否則可能導致起火、異常動作、人身傷害。

警告

- 發生異常、故障時，立即停止使用，拔掉電源插頭。(否則可能冒煙、起火、觸電)
<異常、故障事例>
 - 接通電源開關後可能不動作
 - 移動電源線，有時通電有時不通電
 - 運行中發出焦臭味、異常聲響
 - 按摩椅變形或者異常發熱
 → 請立即委託授權服務中心檢查和修理。

產品規格

產品名稱	SMART RELUXE MASSAGE CHAIR
型號	OG6383
額定電壓	220-240V~
額定頻率	50-60Hz
額定功率	65W
定時	5/10/15/20/25/30分鐘
尺寸 (長*寬*高)	直立狀態: 1480x750x1080mm(L×W×H)
	倒背狀態: 1740x750x805mm(L×W×H)
重量	毛重:約101 公斤
	淨重:約83.5公斤
線長	手控器線長: 90厘米
	電源線長: 180厘米
使用環境	環境溫度:10°C~ 40°C
	相對濕度:0-85RH
儲存環境	環境溫度:20°C~ 60°C
	濕度水平 :20% ~ 80%
安全功能	具備過熱，過流保護
使用益處	促進血液循環，放鬆機體

對於體重100kg或以上的人士，產品運作時可能產生更大的噪聲而且面料外罩可能磨損得更快。

聯繫我們



MALAYSIA
Healthy World Lifestyle Sdn Bhd
No. 22 Jalan Anggerik Mokara 31/47
Kota Kemuning, 40460 Shah Alam
Selangor Darul Ehsan, Malaysia
Tel : +603-5121 4286
Fax: +603-5121 4386



HONG KONG, CHINA
OGAWA Health Care International (HK) Ltd
31/F,YHC Tower,1Sheung Yuet Road
Kowloon Bay
Kowloon
Hong Kong
Tel:+852 3465 6262
Fax:+852 2410 0119



SINGAPORE
OGAWA Health-Care Pte Ltd
27 Tampines Industrial Avenue 5,
T5 @ Tampines
Singapore 528623

Tel:+065-6846 8588
Fax:+065-6846 7677



VIETNAM
OGAWA Vietnam Co Ltd
2nd floor,Petroland Tower,
12 Tan Trao,Tan Phu ward
District 7
Ho Chi Minh
Tel:+84 8 3775 3093/3775 3094
Fax:+84 8 3775 3095



INDONESIA
PT. CITRA PRATAMA MEDIKARYA
JL. Pangeran Jayakarta Komplek 20
Blok B No. 6. Mangga Dua Selatan.
Sawah Besar. Jakarta Pusat 10730,
Indonesia
Tel : (62) 21 6000722
Fax : (62) 21 6000731



PHILIPPINES
O-Healthcare Solution Phil. Inc.
2303, 4th Floor, G&A Building,
Chino Roces Avenue Extension,
Makati City, Philippines
Tel : +632 8889 0676/ +632 8844 6851
Fax: +632 8812 0421