

MOTION X

TREADMILL

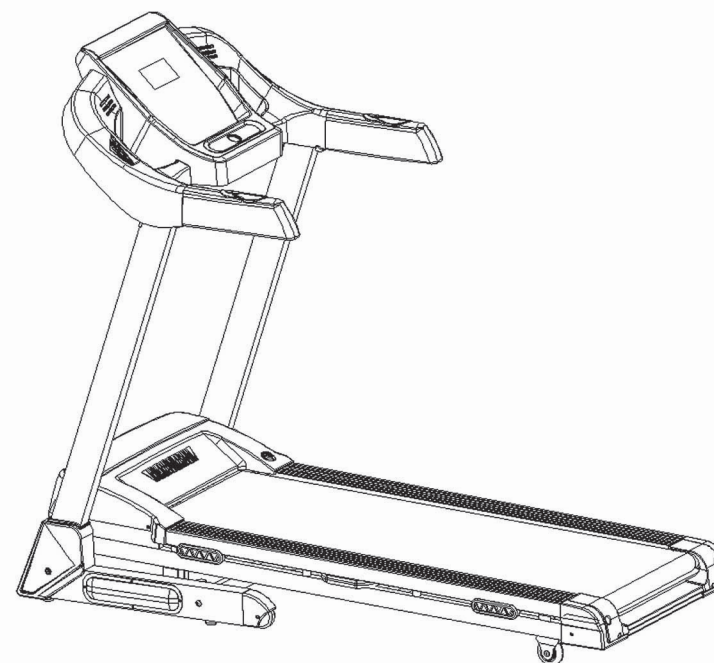

CONTENT

SAFETY INSTRUCTIONS	01
WARRANTY CLAIM	04
PRODUCT PART	05
PRODUCT INSTALLATION	08
PRODUCT OPERATION GUIDE	10
PRODUCT MAINTENANCE	22
PRODUCT SPECIFICATION	25
CONTACT US	26

Thank you for purchasing the OGAWA Motion X Treadmill
Before operating this unit, please read this manual carefully to ensure optimum performance and safety. This manual should be kept available for future reference.

REMARKS:

Our company reserves the right to change the design and the final product
Explanation authority
Product color is subjected to the actual product.

CAUTION

Never use the treadmill before securing the safety key clip to your clothing.

▲ Warning:

To reduce the risk of electric shock and serious injury, please read all important safety instructions, precautions and warnings before using your treadmill. It is the responsibility of the owner to ensure that all users of this treadmill are adequately informed. Please save these instructions for future references.

1. Follow Instructions – All operational and usage instructions should be followed.
2. Do Not Remove Cover – No user-serviceable parts inside. Refer the servicing to qualified service personnel.
3. Connect This Treadmill to A Properly Grounded Outlet Only.
4. Do Not Share The Outlet With Other High-Power Household Appliance – Such as Microwave oven, air-conditioning, etc.
5. This product is for use on a nominal 240-volt and 10-amp circuit.
6. Indoor Use Only – Do not use this treadmill near moisture and dust area.
7. Never place objects of any kind on the treadmill. Never spill liquid of any kind on the treadmill.



马来西亚

MALAYSIA

Healthy World Lifestyle Sdn Bnd

No.22 Jalan Anggerik Mokara 31/47

Kota Kemuning, 40460 Shah Alam Selangor Darul Ehsan, Malaysia

电话: 1800 88 4688

传真: +603-5121 4386

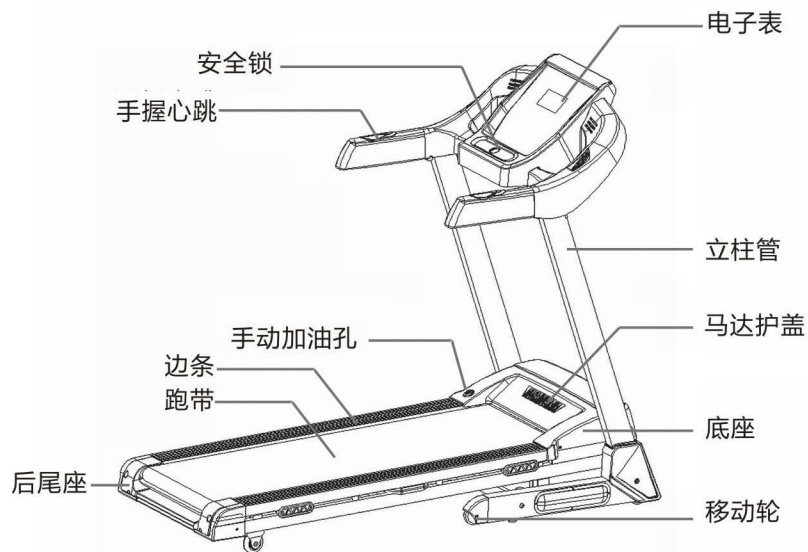

1. 技术参数

型号名称	Motion X
产品型号	OG 1420E
工作电压	AC220V-240V 50/60Hz
最大载重	100kg
有效跑步面积	1230*420 (mm)
马达功率	峰值2.0HP
时间范围	最大99分钟
颜色	黑色
功能	跑步、自动加油系统、蓝牙连接App, 专利减震

注：产品会不定期升级，客户以收到的实物为准，解释权归浙江荣顺科技有限公司所有。

8. Only one person on the treadmill at a time.
9. Wear appropriate exercise clothes and shoes when using the treadmill. Do not wear loose clothes that could become caught in the treadmill.
10. Children under the age of 12 should not use the treadmill without adult supervision.
11. Keep the product away from hot surfaces.
12. Cleaning or Maintenance - Unplug the power cord before cleaning or maintenance.
13. Do Not Operate the Treadmill- if the power cord or plug is damaged, or if the treadmill is not working properly.
14. Place the treadmill on a flat surface only.
15. If you experience any kind of symptoms, including but not limited to chest pain, surfeit, nausea, dizziness, or shortness of breath, stop exercising immediately and consult your physician before continuing.
16. Please consult your doctor before running, if you experience any one of the following diseases:
 - Cardiopathy, hypertension, sugar diabetes, respiratory disease, smoking, and other chronic diseases, complication disease.
 - If you are over 35 years old and overweight.
 - Women who are pregnant or in breast feeding period.
 - If you are using pacemaker or any kind of medical equipment.
17. Unplug the power cord after operating this treadmill.
Do not lift or move this treadmill unless it is in the upright folded

position with the lock latch secure.

18. Do not lift or move this treadmill unless it is fully assembled.
19. Do not start the treadmill while you are standing on the running belt. Always hold the handrails while jogging and running until you feel comfortable without needing to hold the handrails.
20. Do not place your treadmill on the thick carpet. That could result damage to the motor from ventilation problem.
21. Please make sure one end of the safety key are placed in the appointed position on the display.
22. Please do not let your children play near your treadmill.
23. This treadmill is intended for-home use only. Do not use this treadmill in any commercial, rental, school or institutional setting. Failure to comply will void the warranty.
24. Read, understand and test the emergency stop procedure before using the treadmill.
25. The pulse sensor is not a medical device. It is intended only as an exercise aid in determining heart rate trends in general.
26. Never leave the treadmill unattended while it is running. Please store the safety key when the treadmill is unused.
27. Inspect and properly tighten all parts of the treadmill regularly.
28. Please unpack the treadmill carton on a flat surface. It is recommended that you place a protective covering on your floor.

③使用者两脚用力不均匀人为造成跑偏现象，空载转动几分钟可恢复正常，对于无法自动恢复的跑偏现象应用随机配带的 6mm 内六角扳手以四分之一圈为单位逐步调节

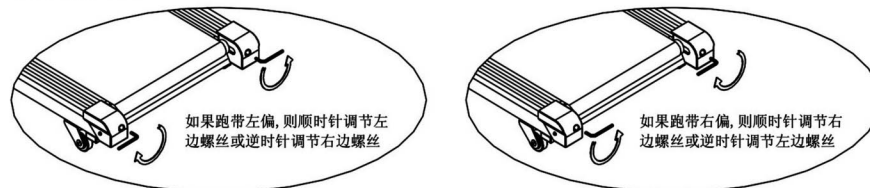

跑带跑偏不属保修范围，主要由用户按照说明书自行维护保养，跑偏会严重损坏跑带，一定要及时发现、及时纠正。

5. 驱动皮带的调整

所有跑步机出厂前都进行过驱动皮带的调整，但使用一段时间后可能还出现松弛打滑现象，主要由用户自行调整。

调整步骤（如右图）：① 用扳手将调整螺栓顺时针转动

② 调整范围以带负载不打滑为准

注意：定期清理皮带沟槽与皮带轮沟槽的夹杂物

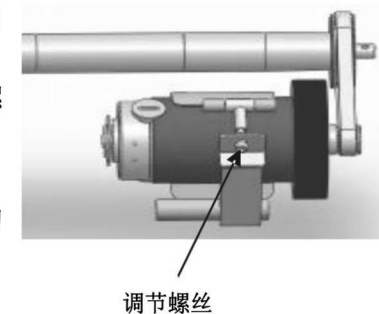

1. 润滑

跑带使用一段时间后，必须用专用配置的甲基硅油进行润滑。

建议：

每周使用时间小于 3 小时	5 个月润滑 1 次
每周使用 4~7 小时	2 个月润滑 1 次
每周使用时间大于 7 小时	1 个月润滑 1 次

不可过量润滑，润滑剂不是越多越好。记住：合理的润滑是提高跑步机使用寿命的重要因素。

2. 润滑方法

至于检查是否需要再上润滑剂的方式，只要抓起跑步带，将你的手尽可能触摸到跑步带背面的中央，假如你的手上沾有硅树脂（有些许潮湿感），即表示不需要再上润滑剂，如果跑板是干燥的并且手中没有粘到硅树脂，

就需要添加润滑剂。

a. 将跑板涂上润滑剂的步骤：

使用硅油滴入马达盖加油孔。

利用 1km/h 的速度来运转跑步机以均匀涂抹硅树脂，并且从左到右轻踩跑步带，大约维持几分钟就可使硅树脂被跑步带完全吸收。

3. 跑带松紧调整

所有跑步机在出厂前和安装后要对跑带进行调整，但使用一段时期后可能还出现松弛现象。如：使用者在跑步时有停顿打滑的现象。当出现此现象时，按顺时针方向以半圈为单位，左右同步调节跑带调整螺栓。跑带过松的话，脚踏在跑带上，跑带和滚筒回合产生打滑现象，但过紧也不好，容易增加电机的负荷，损坏电机、跑带和滚筒等。

4. 跑带跑偏调整

所有跑步机出厂前和安装后都要进行跑带调整，但使用一段时期后它可能还会出现跑偏的现象，造成现象原因有以下：

- ①主机摆放不平稳
- ②使用者运动时双脚不在跑带中心

1. Warranty is not transferable.
2. This warranty is effective only if the product is purchased from OGAWA or its authorized dealers.
3. Proof of purchase (original receipt) is required for all warranty repairs.
4. All implied warranties, including but not limited to these implied warranties of fitness and merchantability, are limited to one (1) year from the date of purchase.
5. Damage due to misuse, improper treatment and unauthorized modification and repairs are not covered by this warranty.
6. Warranty does not cover accessories and add-ons, which do not belong to this product.
7. Warranty is not effective to rental, business, commercial, institutional or other non residential user.
8. All services covered by this warranty must be approved by OGAWA and repaired by authorized technicians only.
9. If replacement parts for defective materials are not available,OGAWA reserves the right to make substitutions in lieu of repair or replacement.

No.	ITEM	DESCRIPTION	QTY	No.	ITEM	DESCRIPTION	QTY
1	computer main cover		1	35	flat pad	φ28*11*M8*18	6
2	computer bottom cover		1	36	base frame tube plug		2
3	computer top cover		1	37	transportation wheel		2
4	computer sticker		1	38	screw	M8*50	2
5	computer		1	39	anti-shock spring		2
6	handrail cover		1	40	plastic cover of anti-shock system		2
7	computer frame		1	41	screw	M4*8	8
8	safety key panel		1	42	screw	M10*55	2
9	hand pulse L/R		2	43	screw	φ10*M6*35	2
10	safety key		1	44	slider		2
11	safety key sticker		1	45	push rod		2
12	MP3 line		1	46	cam		2
13	screw	ST4*10	32	47	coupled axle	φ12	2
14	screw	ST4*20	4	48	screw	M10*45*S20	2
15	screw	M8*20	6	49	bearing 1	φ12	4
16	screw	φ8*M6*24.5	2	50	bearing 2	φ10	2
17	M8 washer		16	51	cotter pin		2
18	screw	M8*45	4	52	soft flat pad	φ23*φ12.3*T2.0	4
19	nut	M8	9	53	soft flat pad	φ23*φ10.3*T2.0	4
20	L upright		1	54	flat shim	φ23*φ10.3*T1.5	2
21	R upright		1	55	main frame		1
22	front cover L/R		2	56	motor cover		1
23	screw	ST4*15	12	57	cushion		1
24	incline frame		1	58	running board		1
25	screw	M10*65	1	59	running belt		1
26	nut	M10	4	60	front roller		1
27	M10 washer		8	61	rear roller		1
28	screw	M10*40	1	62	multi-groove belt		1
29	screw	M10*45	2	63	side stripe	pvc	2
30	incline motor		1	64	side stripe slider	φ42*φ15*T5.0	8
31	air cylinder	760*15KG	1	65	screw	ST5*16	8
32	screw	M8*45	1	66	screw	M8*25	4
33	screw	M8*30	1	67	screw	M6*20	4
34	base frame		1	68	air cushion		2

跑步机运动不顺畅,无力或有抖动	C 显示驱动 IC 不良	需修理, 焊接新的显示驱动 IC
	A 传动部位有阻力	调整传动部位, 或加润滑油
	B 传动带过紧或过松	调节传动带松紧
---或---(或按客户要求显示 E00/E07)	C 驱动器扭力过小或过大	调节扭力电位器至适当位置
	A 安全锁脱落	将安全锁放至面板上吸合或插卡位置
E01-通讯故障(驱动器未收到电子表信号);	B 磁控管未吸合	磁控管装至正确位置
	A 电子表信号线未接好或接触不良	重新接插线
E13-通讯故障(电子表未收到驱动器信号)	B 电子表信号线破损有短路或开路	更换信号线
	C 电子表信号线路故障	更换电子表
E02-失速保护(防爆冲保护或主电机异常)	D 驱动器信号线路故障	更换驱动器
	A 电机线未接插好, 或电机内部开路	重插电机线, 或更换电机
	B 驱动器 IGBT 击穿损坏	更换驱动器
E03-无速度传感信号(有速度感应驱动器)	C 外部交流电压过低	停止使用, 请电工排除故障
	A 速度信号线未接好, 或传感器损坏	重插速度信号线, 或更换传感器
E04-升降自检学习失败(带升降驱动器)	B 驱动器传感线路不良	更换驱动器
	A 升降电机线或信号线未接插好	检查连线是否接错, 重插连接线
	B 升降电机不良	更换升降电机
E05-过流保护	C 驱动器不良	更换驱动器
	A 负载过大	系统保护, 人为堵转则重启即可
	B 传动部位卡死或阻碍	调节传动部位, 或加润滑油
	C 电机内部短路	更换电机
E06-通常为电机开路	D 驱动器烧坏	更换驱动器
	A 电机线未接插好	重新接插电机线
	B 电机内部开路	更换电机
E08-存储 24C02 错误(外带 24C02 驱动器)	C 电机空转	电流过小时报错, 请装机测试
	A 存储 IC 未插到位(非开关电源)	重新插到 IC 座上, 注意 PIN1 脚位置
E09-倒置错误(带倒置驱动器)	B 存储 IC 损坏, 或相关线路不良	更换存储 IC, 或更换驱动器
	A 跑步机竖立, 或者放置不水平	调整跑步机, 水平放置
E10-通常为电机瞬间峰值电流异常, 过流保护	B 驱动器倒置线路不良	更换驱动器
	A 驱动器扭力过大	调节扭力电位器至适当位置
	B 电机内部短路	更换电机
E11-外部交流电压过压(按客户要求)	C 传动部位卡死	调整传动部位, 或加润滑油
	交流过压: 220V 系统时高于 270VAC; 110V 系统时高于 150VAC	停止使用, 请电工排除故障
E14-外部交流电压欠压(按客户要求)	交流欠压: 220V 系统时低于 160VAC; 110V 系统时低于 70VAC	停止使用, 请电工排除故障

(十六)、卡路里计算公式

$$70.3 \times V(\text{Km/h}) \times t(\text{h}) \times (1+\%)$$

在扬升为 0 的情况下每跑一公里消耗的卡路里是 70.3 大卡

(十七)、蓝牙使用功能

扫描面贴上的二维码, 下载安装APP, 即可使用蓝牙功能。打开蓝牙, 点击APP, 在APP里连接跑步机。

APP名称 SPAX, 可在app商城或者google play里搜索下载。

(安卓系统需要版本4.3及以上, 并且少数不知名品牌无法支持该app, IOS系统要求手机4S及以上)

(九)、各数值显示范围:

设置参数	初始	设定初始值	设定范围	显示范围
时间(分:秒)	0:00	15:00	5:00-99:00	0:00-99:59
速度(KM/H)	0.0	N/A	N/A	1.0-14.0KMH
坡度(段)	0	N/A	N/A	0-15
距离(公里)	0.00	1.00	0.50-99.9	0.00-99.9
心率(次/分钟)	P	N/A	N/A	50-200
卡路里(千卡)	0.0	50.0	10.0-999.0	0.0-999.0

(十)、安全锁功能:

在任何状态下,拉掉安全锁都可以紧急停止跑步机的运行,跑步机紧急停止,速度窗口”显示“---”,蜂鸣器发出“BB”的报警3声;此时跑步机除关机外不能进行其它任何操作,将安全锁重新正确装上后,跑步机重新进入待机状态,等待输入指令。

(十一)、节电模式:

本系统具有节电功能,在待机状态下如果10分钟内没有任何按键指令输入,系统进入节电模式,自动关闭显示,按任意键可重新唤醒系统。

(十二)、MP3功能:

当通电后连接MP3或其它的音频设备时,电子表可以播放音乐。声音的大小控制是在音频设备上的,请注意控制声音的大小以免影响声音的质量及内置的音频电路。

(十三)、关机:

在任何时候都可通过关闭电源开关的方式来关闭跑步机,这样并不会损坏跑步机。

(十四)、注意事项:

- 1、运动前先检查是否加载电源;检查安全锁是否有效。
- 2、在运动过程中出现异常情况,可拉掉安全锁,跑步机会迅速减速至停止;再放入安全锁,设备复位,等待输入指令。
- 3、本机若有问题请与经销商联系,非专业人员,请勿试图拆卸或者维修以免造成设备损坏。

(十五)、电跑简易故障排除方法:

故障或现象	可能发生的原因	处理方法
跑步机无显示	A 没有接插电源,或无电源	电源线接入交流,或检查交流插座
	B 电源开关未打开	将电源开关置于ON位置
	C 驱动器无供电或损坏	重按下过载保护器,或更换驱动器
	D 电子表信号线断路	更换信号线,重新接插好
	E 电子表损坏	更换电子表
	F(液晶)背光不亮	需修理,检查背光线,或者更换背光
跑步机显示不全,缺笔画	A 显示驱动IC虚焊或连焊	需修理,检查焊点,重焊接到位
	B(液晶)导电条滑动,未固定到位	重新装配液晶

NO.	ITEM	DESCRIPTION	QTY
69	cushion	φ20*19*M6*10	4
70	rubber	35*35*T3.0	4
71	silica gel chshion		4
72	PU wheel		
73	screw	φ8*M6*30	2
74	screw	M8*60	3
75	oil spray pipe		1
76	pipe slip		2
77	main frame rear cover		1
78	rear cover L/R		2
79	motor bottom board		
80	screw	ST4*15	12
81	plastic fixing of motor cover	PE	4
82	power line	0.75mm ²	1
83	overload protection device	5A	1
84	power switch		1
85	AC connecting wire	red	1
86	AC connecting wire	green	1
87	AC connecting wire	yellow	1
88	power line buckle	SB6R-3	1
89	controller		1
90	screw	ST4*20	2
91	motor	DC	
92	base frame of motor		
93	adjuster of motor		
94	screw	M8*15	2
95	screw	M8*80	1
96	screw	M8*45	1
97	spring washer	M8	2
98	nut	M8	1
99	signal wire		1
100	screw	ST3*10	32
101	screw	ST3*8	2

Explosion Diagram

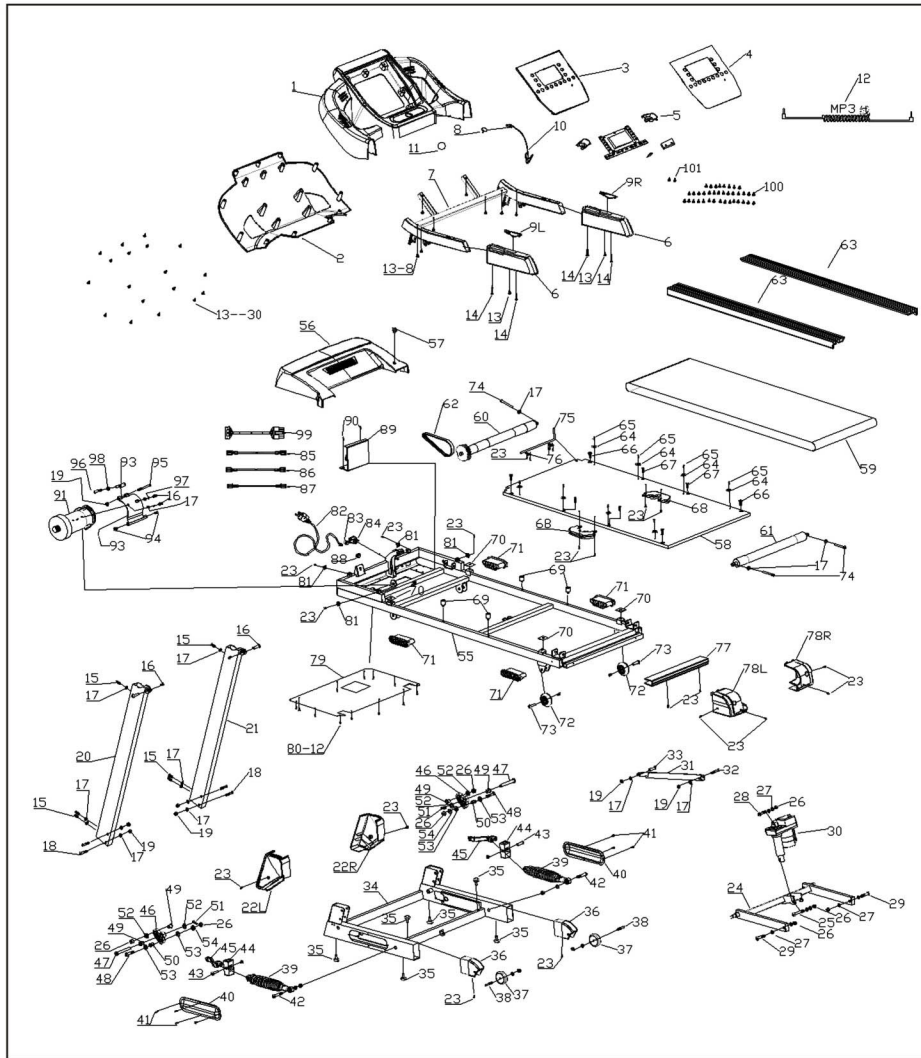

P13-01

程式	时间段	设置的时间 / 20= 每个段的运行时间																			
		1	2	3	4	5	6	7	8	9	10	11	12	13	14	15	16	17	18	19	20
P01	SPEED	2	3	3	4	5	3	4	5	5	3	4	5	4	4	4	2	3	3	5	3
	INCLINE	0	7	7	6	6	5	5	4	4	3	3	2	2	2	2	2	2	3	3	4
P02	SPEED	2	4	4	5	6	4	6	6	6	4	5	6	4	4	4	2	2	5	4	1
	INCLINE	0	3	3	5	5	7	7	9	9	7	7	5	5	3	3	3	3	5	5	7
P03	SPEED	2	4	4	6	6	4	7	7	7	4	7	7	4	4	4	2	4	5	3	2
	INCLINE	0	5	5	1	1	5	5	5	1	1	5	5	5	1	1	5	5	5	5	1
P04	SPEED	3	5	5	6	7	7	5	7	7	8	8	5	9	5	5	6	6	4	4	3
	INCLINE	0	2	3	4	5	6	7	7	6	5	4	3	2	1	1	2	3	4	5	6
P05	SPEED	2	4	4	5	6	7	7	5	6	7	8	8	5	4	3	3	6	5	4	2
	INCLINE	0	2	3	4	5	6	7	7	6	5	4	3	2	1	1	2	3	4	5	6
P06	SPEED	2	4	3	4	5	4	8	7	5	7	8	3	6	4	4	2	5	4	3	2
	INCLINE	0	2	3	4	5	6	7	7	6	5	4	3	2	1	1	2	3	4	5	6
P07	SPEED	2	3	3	3	4	5	3	4	5	3	4	5	3	3	3	6	6	5	3	3
	INCLINE	2	3	4	5	6	7	8	9	9	9	9	9	8	7	6	5	4	3	2	2
P08	SPEED	2	3	3	6	7	7	4	6	7	4	6	7	4	4	4	2	3	4	4	2
	INCLINE	0	3	3	5	5	7	7	9	9	7	7	5	5	3	3	3	3	5	5	7
P09	SPEED	2	4	4	7	7	4	7	8	4	8	9	9	4	4	4	5	6	3	3	2
	INCLINE	0	2	2	2	2	2	2	2	2	2	2	2	2	2	2	2	2	2	2	2
P10	SPEED	2	4	5	6	7	5	4	6	8	8	6	6	5	4	4	2	4	4	3	3
	INCLINE	9	8	7	6	5	4	3	3	4	5	6	7	8	9	9	8	7	6	5	4
P11	SPEED	3	4	5	9	5	9	5	5	9	5	5	5	5	9	9	8	7	6	5	4
	INCLINE	9	8	7	6	5	4	3	3	4	5	6	7	8	9	9	8	7	6	5	4
P12	SPEED	2	5	8	10	7	7	10	10	7	7	10	10	6	6	9	9	5	5	4	3
	INCLINE	2	2	2	2	2	2	2	2	3	3	3	3	3	3	3	4	4	4	4	4

(八)、 体质测试:

在待机状态下,连续按“程式”键进入人体体质指数(FAT)检测功能,按“模式”键可进入F-1、F-2、F-3、F-4、F-5界面(F-1—性别,F-2—年龄,F-3—身高,F-4—体重,F-5—体质检测),按“速度+”、“速度-”、“扬升+”、“扬升-”可对01—04的参数进行设置(参数如下表),设置完后再按“模式”键进入F-5体质检测界面,此时双手握住手握心率板5-6秒后将显示你的体质指数,查看你的体重和身高是否相称。体质指数(FAT)是衡量一个人身高和体重的关系,不是指身体比例,FAT适合于任何的男性和女性,与其他健康指标一起为人们提供调整体重的依据。理想的FAT应该在20—24之间,如果低于19意味着太瘦,如果介于25和29之间即是超重,而如果超出30则认为是肥胖。(该数据只供参考,不能当作医学数据。)

F-1	Seg	01 男	02 女
F-2	Age	10-----99	
F-3	Height	100-----200	
F-4	Weight	20-----150	
F-5	FAT	≤19	Underweight
	FAT	=(20---24)	Normalweight
	FAT	=(25---29)	Overweight
	FAT	≥30	Obesity

(四)、 运动过程中的操作:

- 1、按“SPEED -”键会降低跑步机的运行速度。
- 2、按“SPEED+”键会增加跑步机的运行速度。
- 3、按“INCLINE -”键会降低跑步机的坡度。
- 4、按“INCLINE+”键会增加跑步机的坡度。
- 5、按停止键跑步机会减速至停止运行。
- 6、当运动者双手握住心跳手握柄时 3 秒左右显示心跳数据。

(五)、 手动模式:











- 1、在待机状态下,直接按“START”键,跑步机以 1.0 公里/小时速度、坡度 0 段开始运行;其它窗口从 0 开始正向计数,按“INCLINE+”、“INCLINE -”、“SPEED+”、“SPEED -”键改变坡度和速度。
- 2、在待机状态下,按“MODE”键进入时间倒计时模式,“TIME”窗口显示“15: 00”且闪烁,按“INCLINE+”、“INCLINE -”、“SPEED+”、“SPEED -”键均可设定运动时间,设定范围为: 5: 00—99: 00。
- 3、在时间倒计时模式时,按“MODE”键进入距离倒计时模式,“DIS”窗口显示“1.00”且闪烁,按“INCLINE+”、“INCLINE -”、“SPEED+”、“SPEED -”键均可设定运动距离,距离设定范围为: 0.50—99.9(连接蓝牙 0.50-60.0)。
- 4、在距离倒计时模式时,按“MODE”键进入卡路里倒计时模式,“CAL”窗口显示“50.0”且闪烁,按“INCLINE+”、“INCLINE -”、“SPEED+”、“SPEED -”键均可设定卡路里,卡路里设定范围为: 10.0—999.0。
- 5、三种倒计时模式选择其中的一种设置完成后再按启动键,跑步机延时 3 秒后开始运行,按“INCLINE+”、“INCLINE -”、“SPEED+”、“SPEED -”键调整速度和坡度;按停止键,跑步机停止运行。

(六)、 内置程式:

本系统共有 12 个内置程式 P01-P12,在待机状态下,按“PROG”键速度窗口显示“P01-P12”,选择喜欢的程式之后,同时“TIME”窗口闪烁;显示预设时间 30: 00,按“INCLINE+”、“INCLINE -”、“SPEED+”、“SPEED -”设定所需的运动时间后,再按“START”键启动内置程式时,内置程式共分 20 段,每段运动时间=设定时间/20。当进入下一段时系统发生“Bi-Bi-Bi”3 声提示,系统的速度与坡度随程式段改变而改变,其间可以按“INCLINE+”、“INCLINE -”、“SPEED+”、“SPEED -”键改变速度和坡度时,但是当程式进入下一段时会恢复成该段的速度与坡度,运行完一个程式,系统会发出“Bi-Bi-Bi”的 3 声提示,跑步机平稳降速停止运行且显示“End”,完全停止后 5 秒进入待机状态。

(七)、 程式说明:

SPEED 代表速度,INCLINE 代表坡度(共 15 段坡度,每个坡度为总坡度的 1/15)。每个程式都是将运动时间分为 20 个等份,每个时间段都有相对应的速度和坡度。

main part	Name		Q'ty	Fitting name		Q'ty
	1, Main frame		1set	2.Plastic cover		2sets
 Main frame			Plastic cover 			
No.	Fittings	Qty	No.	Fittings	Qty	
(1)	 M8*20	6	(7)	 5,6mm Wrencd	1	
(2)	 M8*45	2	(8)	 Multi-wrencd	1	
(3)	 Flat washer	8	(9)	 Silicone oil	1	
(4)	 ST4X15	2	(10)	User's Manual	1	
(5)	 M8 Nut	2				
(6)	 M4X10	8				

Note: our company reserves the right to reform the products without notice.

Step 1:

1. Take out the main frame out from the box and put it onto the floor, and clear the fittings.
2. use 4pcs M8*20 and 2pcs M8X45 screws and fix them onto the stand pipe with washers.

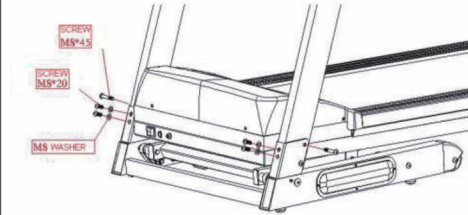

step 2:

1. Raise the computer panel while check the signal connection, and insert 2pcs M8*20 screws with washers to fasten it.

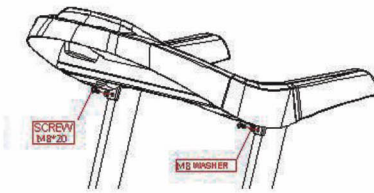

Step 3: Use 2pcs ST4X15 screws to fasten the plastic cover at bottom of stand pipe.

Use 8pcs M4X10 screws to fasten the spring plastic cover at base frame.

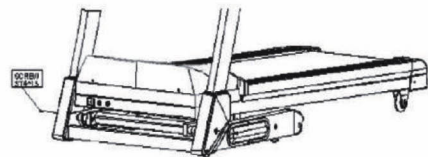

4、“CAL.”窗口:

显示卡路里:

显示消耗热量值, 显示消耗热量值时, 正向计数时从 0.0-999.0, 溢出后清零重新计数, 反向计数时, 则从设定值倒计至 0, 当倒计至 0 时跑步机平稳降速停止运行且显示“End”, 完全停止后 5 秒进入待机状态。

5、“PUL./INCL”窗口:

心跳显示:

显示运动者的心跳值, 当运动者双手握住心跳感应手把时系统能自动侦测到运动者的心跳频率并在此窗口显示, 心跳值显示范围: 50-200 次/分。(该数据只供参考, 不能当作医学数据。)

显示扬升:

显示当前坡度值, 坡度显示范围: 0-15 段。

(二)、按键功能:

- 1、“PROG”为程式键: 在待机状态时, 按此键可以循环选择“P01-P02……P12-FAT”。“P01-P12”为内置程式。“FAT”为测脂。
- 2、“MODE”为模式选择键: 按此键可以循环选择“0: 00”、“15: 00”、“1.0”、“50.0”(“0: 00”为手动模式, “15: 00”为时间倒计模式, “1.0”为距离倒计模式, “50.0”为卡路里倒计模式。)在选择各种模式时均可使用速度和坡度加减键来设定相关倒计数值, 设定完成后按“START”键即可启动跑步机。
- 3、“START”为启动键: 在电源开启并且安全锁吸合的情况下, 任何时候按此键, 可启动跑步机的运行。
- 4、“STOP”为停止键: 在运动过程中可通过此按键来停止跑步机的运行并复位清零。
- 5、“SPEED+”、“SPEED-”为速度加减键: 待机状态, 用以调整设定值。启动后用于调整速度, 其调整幅度值为 0.1 公里/次, 当持续按住超过 0.5 秒时自动持续递增或递减。
- 6、“INCLINE+”、“INCLINE-”为坡度加减键: 待机状态, 用以调整设定值。启动后用于调整坡度, 其调整幅度值为 1 段/次, 当持续按住超过 0.5 秒时自动持续递增或递减。
- 7、“SPEED: 3、6、9”KMH 为速度快捷键: 可快速进行速度设定。
- 8、“INCLINE: 3、6、9”% 为坡度快捷键: 可快速进行坡度设。
- 9、“加油”键: 非设置加油时间, 按此键加油, 加油时间 3 秒。
- 10、在待机状态下, 按住“速度+”和“速度-”键 3 秒, 进入总里程查看, 在查看状态下按“停止”键 3 秒清除总里程。

(三)、快速启动(手动模式):

- 1、打开电源开关, 将磁性安全锁正确吸附在面板下方的安全锁位置。
- 2、按“START”启动键, 系统进入 3 秒倒计时, 蜂鸣器发出声音, 同时速度窗口显示倒计时数, 3 秒倒计时完毕后跑步机以 1 公里/小时的速度开始运行。
- 3、启动后可根据需要, 使用“SPEED+”、“SPEED-”键调整跑步机的速度; 使用“INCLINE+”、“INCLINE-”键调整跑步机的坡度。

5. 缝匠肌（大腿内侧的肌肉）伸展

脚底相对，膝盖朝外坐下。双手抓住双脚向腹股沟方向拉。保持 10~15 秒，然后放松。重复做 3 次（见图 5）。



(一)、窗口显示:

1、“SPEED”窗口:

在运行状态下显示当前速度值，速度显示范围：1.0-14.0KM/h。
 在启动倒计时，显示“3”、“2”、“1”。
 在程式选择和设置时，显示“P01-P02----P12-FAT”。

2、“TIME”窗口:

时间显示:

显示运动时间，正向计时从 0:00-99:00，计时到 99:59 时跑步机平稳降速停止运行且显示“End”，完全停止后 5 秒进入待机状态；倒计时则从设定的时间递减至零，当倒计时至 0:00 时跑步机平稳降速停止运行且速度窗口显示“End”，完全停止后 5 秒进入待机状态。

3、“DIS.”窗口:

显示距离:

显示运动距离，正向计数从 0.00-99.90，溢出后清零重新计数，反向计数则从设定值递减至零，当倒计时至 0 时跑步机平稳降速停止运行且速度窗口显示“End”，完全停止后 5 秒进入待机状态。

Before using your treadmill, it is best to take 5 -10 minutes doing warm up stretching exercises. Stretching prior to exercise will improve flexibility and reduce chances of exercise related injury.

1) Downward stretch

The body bends forward slowly so that the back and shoulders relaxed, hands to touch the toes as far as possible. Maintain 10 to 15 seconds, and then relax. Repeated 3 times (see Figure 1).

2) Crus sinew stretch

Put one leg straight, the other leg inward to keep straight the inside. A hand to touch the toes as far as possible. Maintain 10 to 15 seconds, and then relax. To do a leg each repeat 3 times (see Figure 2).

3) Crus and heal sinew stretch

Two hands extending wall or table stand, one foot in the post. Hind legs to keep upright and lean to the walls or trees direction. Maintain 10 to 15 seconds, and then relax. To do a leg each repeat 3 times (see Figure 3).

4) muscles stretch

Right hand extending the wall or cable, keep balance, then the left hand back stretch to seize the left ankle to the hips slowly pulls, until you feel the front thigh muscles tense. Pull about 10 ~ 15 seconds, then relax. To do a leg each repeat 3 times (see Figure 4).

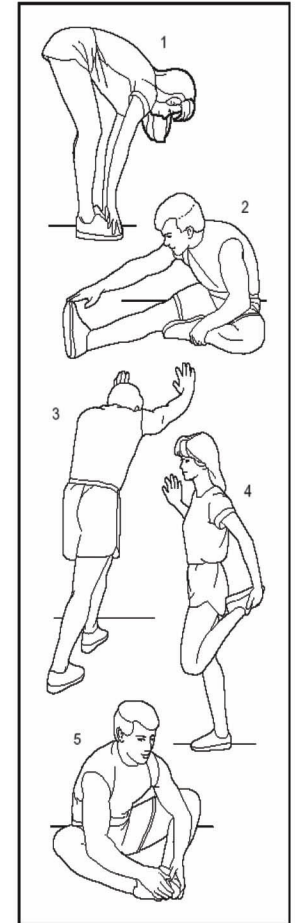

5) Sartorius muscle (inner thigh muscles) stretch

The sole of the feet relative, seated knee outward. Hands grasp the feet to the groin direction pull slowly. Maintain 10 to 15 seconds, then relax. Repeated 3 times (see Figure 5).

TREADMILL OPERATION

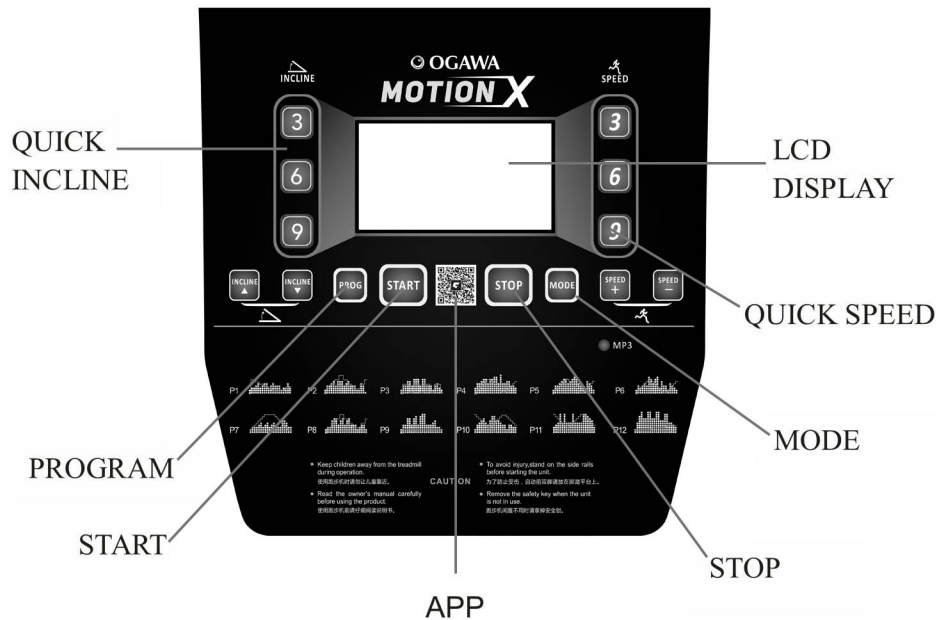

热身 每次使用本机前需有 5-10 分钟的热身运动。

呼吸 运动时不可屏住呼吸，通常准备还原动作时以鼻吸气，以口将气用力吐出，呼吸与动作应协调，如呼吸过于急促，应立即停止运动。

频率 同一部位肌肉的锻炼应有 48 小时的休息，也就是隔一天才能训练相同的部位。

负荷 按照个人体能状态决定训练的份量，然后依渐近负荷的原则来练习，初训练时肌肉酸痛是正常现象，只要继续练习，酸痛即可消除。

放松 每次练习后要做 5 分钟的还原动作，尤其是脚部肌肉的伸展松弛，以免肌肉长期凝结，保持肌肉弹性。

饮食 为保护消化系统，饭后一小时后方可锻炼，训练后至少应隔半小时才可进食，锻炼中少喝水，尤忌大量饮水，以免增加心、肾负担。

伸展运动 不管您以怎样的速度跑步，最好先做做伸展运动。温暖的肌肉更容易舒展，因此先走上 5~10 分钟来热身。接着停下来按照如下方法做伸展运动——做 5 次，每条腿每次做 10 秒或更多时间，在锻炼结束后再做一遍。

1. 向下伸展 双膝微曲，身体慢慢向前弯，让背部和肩膀放松，双手尽量去触摸脚趾。保持 10~15 秒，然后放松。重复做 3 次（见图 1）。

2. 脚筋伸展 坐在干净的座垫上，把一条腿伸直。把另一条腿向内收，使其紧贴伸直的一条腿的内侧。尽量用手去触摸脚趾。保持 10~15 秒，然后放松。每一条腿重复做 3 次（见图 2）。

3. 小腿和脚跟腱伸展 两手扶墙或桌子站立，一脚在后。保持后腿直立且脚跟着地，向墙或树的方向倾斜。保持 10~15 秒，然后放松。每一条腿重复做 3 次（见图 3）。

4. 四头肌伸展 以右手扶墙或桌子掌握平衡，然后左手向后伸，抓住左脚踝慢慢向臀部上拉，直到您感觉到大腿前面的肌肉很紧张。大约上拉 10~15 秒，然后放松。每一条腿重复做 3 次（见图 4）。

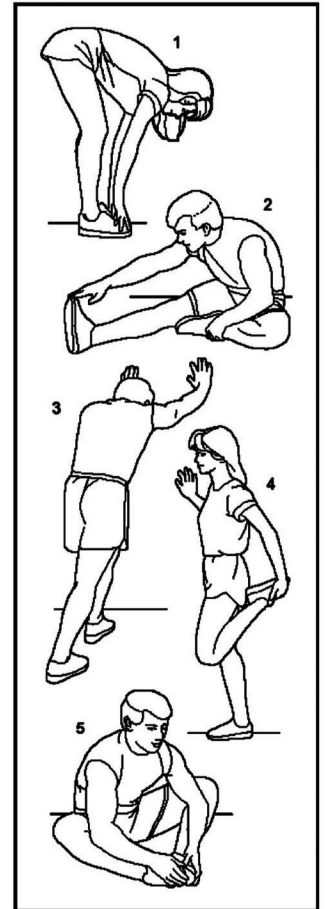

2. 装箱清单

			 <p>立柱卡套</p>		
序号	配件	数量	序号	配件	数量
1	 M8X20	6	6	 M8 螺母	2
2	 M4X10	8	7	 5、6mm 内六角板手	2
3	 ϕ 8.5 垫片	8	8	 硅油	1
4	 M8X45	2	9	 多功能扳手	1
5				 ST4*15	2

步骤1:

- 取出主框架, 并把它放在地板, 并明确配件。
- 使用4个M8*20的和2个M8x45带垫圈螺钉固定到支架上

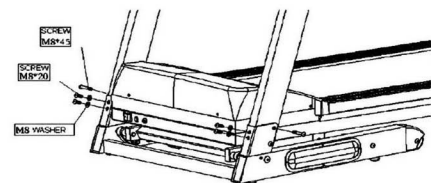

步骤2:

- 在检查信号时确定立柱线是否连接好, 并将2个M8×20螺钉带垫圈紧固。

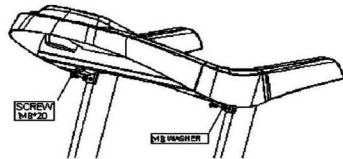

步骤3

- 安装上立柱卡套
- 使用2个4*15螺丝固定卡套
- 使用8颗M4*10螺丝固定弹簧减震塑料盖

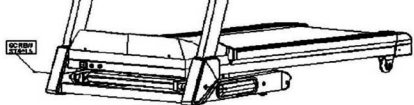

1.1. Brief Introduction

This console is easy to use, and has only less parameters.

Term used in the instruction:

Treadmill's parameters: value of "speed"

Exercise parameter: value of "distance", "calorie", "time" and "heartrate".

Exercise mode: manual, mode and program

Manual exercise mode: exercise mode without setting exercise amount.

Pattern exercise mode: exercise mode without setting exercise amount.

A. Time exercise mode: set exercise time, e.g. 30 minutes.

B. Distance exercise mode: set exercise distance, e.g. 3 square kilo meters.

C. Calorie exercise mode: set the calorie figure you want to consume, e.g., 50 calories.

D. Program exercise mode: different exercise program originally set in the treadmill, and this treadmill has 12 exercise programs.

1.2. Display

Its display is LCD big blue screen.

Display contents:

- Heartbeat
- Time
- Distance
- Calorie
- Speed
- Incline

1.3. Keys

The keys of this product are as follows:

- 3 speed direct select keys (3,6,9)
- 3 incline direct select keys (3,6,9)
- 1 start key
- 1 stop key
- 2 Speed +/- keys, 2 incline +/- keys

F. 1 program key

G. 1 mode key

1.4. Parameters

A. Power voltage 220-240V

B. Minimum speed 1.0Km/h

C. Max speed 14Km/h

D. Incline 0-15%

E. Longest exercise time in time mode: 99 minutes.

F. Shortest exercise time in time mode: 5 minutes.

G. Longest exercise distance in distance mode: 99.9 Km.

H. Shortest exercise distance in distance mode: 0.5 Km.

I. Biggest calorie figure in calorie mode: 999 Cal.

J. Lowest calorie figure in calorie mode: 10 Cal.

K. Shortest time of (P1—P12) program: 5 minutes.

L. Longest time of (P1—P12) program: 99 minutes.

1.5. Safe key

In any condition, switch down the safe key, the system closes, give the warning sound and display. (all the screens display "-")

1.6. Exercise mode

The exercise modes have a common precondition:

A. the system is powered up.

B. the safe key is placed correctly.

(1). Manual

A. Enter

Press the "Start" key, the "speed" is counted down from 3 to 1, the buzzer gives a warning sound and the system is started up.

B. Treadmill regulation

Press "speed+", "speed-" keys to regulate the speed.

C. The treadmill counts the exercise parameter and refresh the display at its window.

D. Adjust the speed shortcut to regulate the speed directly.

E. Adjust the incline shortcut to regulate the incline level

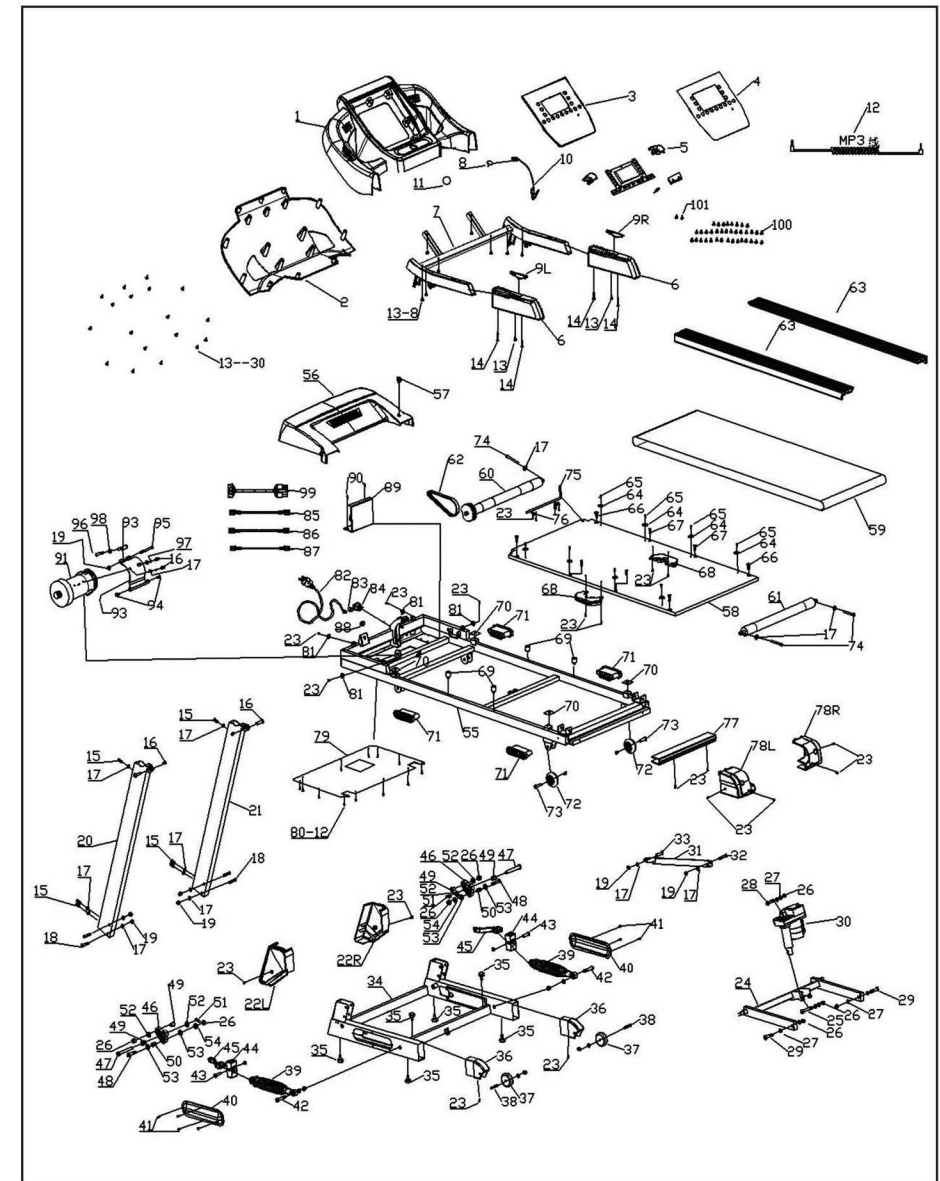

序号	零件名称	型号/规格	数量
69	缓冲垫	φ 20*19*M6*10	4
70	橡胶垫	35*35*T3.0	4
71	缓冲块		4
72	PU轮		
73	半圆头内六角对口螺丝	φ 8*M6*30	2
74	圆柱头内六角螺丝	M8*60 (全牙)	3
75	喷油管	φ 6.5*T1.2*L450	1
76	管卡		2
77	主架后装饰盖		1
78	后护罩L/R		2
79	马达下盖		
80	十字带垫自攻自钻螺丝	ST4*15	12
81	马达盖固定塑料件	PE	4
82	电源线	0.75mm ²	1
83	过载保护器	5A	1
84	电源开关	15A250V	1
85	AC连接线	红	1
86	AC连接线	绿	1
87	AC连接线	黄	1
88	电源线扣	SB6R-3	1
89	控制器		1
90	十字带垫自攻自钻螺丝	ST4*20	2
91	电机	DC	1
92	电机固定架		
93	电机调节件		
94	半圆头内六角螺丝	M8*15	2
95	半圆头内六角螺丝	M8*80	1
96	圆柱头内六角螺丝	M8*45	1
97	弹簧垫片	M8	2
98	法兰螺母	M8	1
99	信号线		1
100	十字带垫自攻螺丝	ST3*10	32
101	十字带垫自攻螺丝	ST3*8	2

directly
 F. Press “stop” key, the system shut down.
 G. When the exercise time exceeds 99:59, the system will not shutdown but count time from 0.

(2). Mode

A. Enter

At the standby state, press “mode” key, the certain screen will flash and display “time”, “distance” and “calorie”. Regulate the exercise mount by regulating the “speed+” and “speed-” keys, then press start to a certain mode, then the system is started up.

B. Treadmill adjustment

Press “speed+” and “speed-” keys to adjust the speed value. Press the speed shortcut to adjust the speed directly.

C. The treadmill computes the exercise parameter and refreshes the display at its window.

D. Press “STOP” key, the system shut down.

E. When the exercise amount exceed the set amount, the system stop, then press “stop” key, the system return to the standby state.

(3). Program

According to scientific arrangement, it has 12 exercise programs within the system (see attachment 1)

A. Enter

Press “PROGRAM” key, select any program from P1-P12, and the time window displays 30:00. You can adjust the value by pressing “speed+” and “speed-” keys or press speed shortcut key to adjust it. Then press “Start” key, the treadmill starts to run at the first speed and incline after three seconds countdown. The program is separated into 20 sections, each section running time is /20 of the setting time. After one section

is finished, it will enter the next section automatically, when all the sections are finished, treadmill will stop.

B. Treadmill adjustment

Press “speed+” and “speed-” keys to adjust the speed

value. Press the speed shortcut to adjust the speed directly. Press “incline+” and “incline-” keys to adjust incline. Press the incline shortcut to adjust the incline directly.

C. The treadmill computes the exercise parameter and refreshes the display at its window.

D. Press “STOP” key, the system shut down.

E. When the program is finished, the system stop, then press “ stop ” key, the system return to the standby state.

1.7 MP3 Function:

When connect with MP3 or mobile phone, the speaker in computer panel can play music, you can adjust sound and track through your MP3 and mobile phone.

1.8 Easy self Lubrication Function:

There is a hole for adding oil on motor cover. After starting machine, pls change to highest speed, then add the oil into the hole, the oil will be spraied from the middel between the running belt and board. (how many days need to lubricate, please check (PRODUCT MAINTENANCE)).

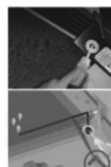

1.9 App system:



Scan the two-dimension code at control panel, download the software named “SPAX”, trun ON the Bluetooth in your mobile and connect with machine inside APP, then your mobile can control the machine. You can download from app store or google

序号	零件名称	型号/规格	数量	序号	零件名称	规格	数量
1	表盘主体		1	35	底座脚垫	φ 28*11*M8*18	6
2	表盘下盖		1	36	底座后管塞		2
3	表芯		1	37	移动轮		2
4	面贴		1	38	半圆头内六角螺丝	M8*50	2
5	上控		1	39	减震器		2
6	发泡扶手		1	40	减震护盖		2
7	表架		1	41	十字半圆头机用螺丝	M4*8	8
8	安全开关钣金		1	42	半圆头内六角螺丝	M10*55	2
9	手握心率L/R		2	43	半圆头内六角对口螺丝	φ 10*M6*35	2
10	安全开关		1	44	减震导向滑块		2
11	安全开关贴纸		1	45	推杆	铝合金	2
12	MP3线		1	46	凸轮	铝合金	2
13	十字大扁头自攻螺丝	ST4*10	32	47	连动轴	φ 12	2
14	十字圆头自攻螺丝	ST4*20	4	48	半圆头内六角螺丝	M10*45*S20	2
15	半圆头内六角螺丝	M8*20	6	49	塑胶轴承1		4
16	半圆头内六角对口螺丝	φ 8*M6*24.5	2	50	塑胶轴承2		2
17	M8垫片		16	51	开口销		2
18	半圆头内六角螺丝	M8*45 (牙长15)	4	52	塑胶软平垫	φ 23*φ 12.3*T2.0	4
19	六角防松螺帽	M8	9	53	塑胶软平垫	φ 23*φ 10.3*T2.0	4
20	左立柱总成		1	54	平垫片	φ 23*φ 10.3*T1.5	2
21	右立柱总成		1	55	主架组件		1
22	立柱侧护盖L/R		2	56	马达盖		1
23	十字半圆头自攻螺丝	ST4*15	12	57	硅胶塞		1
24	扬升架组件		1	58	跑步板		1
25	半圆头内六角螺丝	M10*65 (牙长30)	1	59	跑步带		1
26	六角防松螺帽	M10	4	60	前滚筒		1
27	M10垫片		8	61	后滚筒		1
28	半圆头内六角螺丝	M10*40 (牙长20)	1	62	多槽带		1
29	半圆头内六角螺丝	M10*45 (牙长20)	2	63	边条	pvc	2
30	扬升电机	220V行程50	1	64	边条滑块	φ 42*φ 15*T5.0	8
31	气弹簧	中心距760*15KG	1	65	十字半圆头自攻螺丝	ST5*16	8
32	半圆头内六角螺丝	M8*45 (牙长20)	1	66	内六角沉头螺丝	M8*25	4
33	半圆头内六角螺丝	M8*30	1	67	内六角沉头螺丝	M6*20	4
34	底座组件			68	气囊		2

是否正确存在疑问，请委托专业电工进行检查。即使该产品附带的插头与插座不配，也不能对其进行改造。请委托专业电工安装合适的插座。

◆该产品具有接地插头。请确认该产品连接至具有与该形状一样的插座 该产品不能使用转接插座。



保修说明

1. 本保权限不可转让
2. 本保修服务仅对在 OGAWA 购买的产品有效
3. 档要求保修服务时请出示正本购买凭据
4. 在保修范围内的微信服务自购买之日起一年内有效
5. 由于错误使用，不合理保养以及未经授权私自改装和维修此产品而导致的损坏，不属于保修范围
6. 此保修范围不包括不属于产品本身的附件
7. 此保修范围不适用于租赁、交易、商业、机构或其他非个人使用者
8. 此保修范围所涉及的微信服务必须经过 OGAWA 授权，且必须授权的技术人员维修
9. 若需更换的维修附件缺货，OGAWA 有权采用替代配件进行维修



PRODUCT OPERATION GUIDE

play.(Android system needs version 4.3 and above.However, certain unfamous mobile brand are not supported. ISO version requires iPhone 4S and above).

program		1	2	3	4	5	6	7	8	9	10	11	12	13	14	15	16	17	18	19	20
		P01	SPEED	2	3	3	4	5	3	4	5	5	3	4	5	4	4	4	2	3	3
	INCLINE	0	7	7	6	6	5	5	4	4	3	3	2	2	2	2	2	2	3	3	4
P02	SPEED	2	4	4	5	6	4	6	6	6	4	5	6	4	4	4	2	2	5	4	1
	INCLINE	0	3	3	5	5	7	7	9	9	7	7	5	5	3	3	3	3	5	5	7
P03	SPEED	2	4	4	6	6	4	7	7	7	4	7	7	4	4	4	2	4	5	3	2
	INCLINE	0	5	5	5	1	1	5	5	5	1	1	5	5	5	1	1	5	5	5	1
P04	SPEED	3	5	5	6	7	7	5	7	7	8	8	5	9	5	5	6	6	4	4	3
	INCLINE	0	2	3	4	5	6	7	7	6	5	4	3	2	1	1	2	3	4	5	6
P05	SPEED	2	4	4	5	6	7	7	5	6	7	8	8	5	4	3	3	6	5	4	2
	INCLINE	0	2	3	4	5	6	7	7	6	5	4	3	2	1	1	2	3	4	5	6
P06	SPEED	2	4	3	4	5	4	8	7	5	7	8	3	6	4	4	2	5	4	3	2
	INCLINE	0	2	3	4	5	6	7	7	6	5	4	3	2	1	1	2	3	4	5	6
P07	SPEED	2	3	3	3	4	5	3	4	5	3	4	5	3	3	3	6	6	5	3	3
	INCLINE	2	3	4	5	6	7	8	9	9	9	9	9	8	7	6	5	4	3	2	2
P08	SPEED	2	3	3	6	7	7	4	6	7	4	6	7	4	4	4	2	3	4	4	2
	INCLINE	0	3	3	5	5	7	7	9	9	7	7	5	5	3	3	3	3	5	5	7
P09	SPEED	2	4	4	7	7	4	7	8	4	8	9	9	4	4	4	5	6	3	3	2
	INCLINE	0	2	2	2	2	2	2	2	2	2	2	2	2	2	2	2	2	2	2	2
P10	SPEED	2	4	5	6	7	5	4	6	8	8	6	6	5	4	4	2	4	4	3	3
	INCLINE	9	8	7	6	5	4	3	3	4	5	6	7	8	9	9	8	7	6	5	4
P11	SPEED	3	4	5	9	5	9	5	5	5	9	5	5	5	5	9	9	8	7	6	3
	INCLINE	9	8	7	6	5	4	3	3	4	5	6	7	8	9	9	8	7	6	5	4
P12	SPEED	2	5	8	10	7	7	10	10	7	7	10	10	6	6	9	9	5	5	4	3
	INCLINE	2	2	2	2	2	2	2	2	3	3	3	3	3	3	3	4	4	4	4	4

Attachment 1: P1-P12 Program Exercise Program

◆不要 2 人以上同时使用，在使用过程中注意不要使周围的人靠近。
——否则可能因跌倒而发生意外伤害。

◆不能自己表达意识或自己不能操作者不要使用。
——可能发生事故或受伤。

5. 勿分解!

◆绝对禁止拆卸、修理、改造。
——有发生机械故障而受伤的危险。

6. 避免接触水!

◆主体或操作部不要淋水或饮料。
——可能导致触电、起火。

7. 禁止!

◆平常不运动的人不要突然做激烈的运动。

◆在饮食过后或疲劳时、刚刚运动或体力状态不正常时，不要使用。
——可能导致损害健康。

◆本品适合于家庭使用，不适用于学校、体育馆等为数多的不特定的场所使用。

——有受伤的危险性。

◆不在饮食、或进行其它活动的同时使用。

◆在饮酒后等感觉到变得迟钝时不要使用。
——可能发生意外伤害。

◆不在裤子口袋里装着硬物的情况下使用。
——可能导致事故或受伤。

◆不使电源插头上附着针、垃圾或水份。
——可能导致触电或短路、起火。

8. 切勿用湿手使用!

◆不要用湿手拔出或插入电源插头。
——可能导致触电和受伤。

9. 拔出电源插头!

◆在不使用时，从插座拔出电源插头。
——因灰尘和湿气会使绝缘劣化，从而导致漏电火灾。

10. 接地说明!  警告

◆该产品必须接地。如果本机发生功能失常，接地将为电流提供阻力最小的通道，以减小触电危险。

◆该产品装备了具有设备接地导体和接地插头的电线。必须将该插头插入已完全依照当地法规或法令进行正确安装和接地的、合适的插座。

77. 危险!

◆若设备接地导体的连接不当，则会导致触电危险。如果您对该产品的接地

- (4) 有循环系统障碍(心脏病、血管障碍、高血压症等)者。
- (5) 呼吸器官有障碍者。
- (6) 正在使用人工心律调整器植入体内型医疗电子仪器者。
- (7) 有恶性肿瘤者。
- (8) 有血栓症或严重的脂肪瘤、急性脂肪瘤等血液循环障碍或各种皮肤感染等症状者。
- (9) 有因糖尿病等引起的高度末梢循环障碍所引起的知觉障碍者。
- (10) 皮肤有创伤者。
- (11) 因生病等而发高烧者(38℃或以上)。
- (12) 背骨有异常者或背骨弯曲者。
- (13) 正在妊娠或可能妊娠者或正处于经期者。
- (14) 感到身体异常, 需要静养者。
- (15) 明显身体状况不佳者。
- (16) 以康复为目的的使用者。
- (17) 除上述情况以外特别感到身体有异常者。

——可能导致事故或身体状况不佳。

◆在运动过程中感到腰痛、腿脚麻木、头晕、心跳等身体与平时不同的疼痛或协调的感觉异常时, 立即停止使用并向医生咨询。

◆不要让儿童使用本产品, 也不要让儿童在本产品周边玩耍。

——如不遵守, 可能会有受伤的危险。

◆在使用过程中或装入拿出产品时、使其滑动时, 请务必确认周围(产品的后、下部、前部)有无人或宠物。

4. 禁止!

◆不要在外壳裂开、破裂、脱落的状态(内部构造露出)或焊接部脱落的状态下使用。

——否则可能发生意外或受伤。

◆在运动过程中不要跳上去或跳下来。

——可能因跌倒而导致受伤。

◆不要在室外和浴室附近等潮湿的场所和淋到水滴的场所使用和保管。

◆不要在阳光直射的场所、炉子周围等高温的场所和电热地毯等出暖器具的上面使用或保管。

——否则可能导致漏电、起火。

◆当电源线或电源插头损坏或插座的插口松弛时不要使用。

——否则可能导致触电、短路、起火。

◆不要损坏或强行弯曲或扭转电源线。同时不要在其上面放置重物, 不要使线被夹住。

——否则将导致火灾或触电。

2.0. Body Fat Test Program:

At the standby state, press the “PROGRAM” key repeatedly to enter into FAT test state, then press mode “key” to enter F-1, F-2, F-3, F-4, F-5 interface (F-1—sex, F- 2—age, F- 3—height, F-5-FAT test), press “speed+” and “speed-“ keys to set the parameters from 01—04 (see the following table); then press “MODE” key to enter F-5 FAT interface, at this time hold heart rate plate for 4-5 seconds, then it will show your FAT, check your weight and height and see whether they match with each other. The FAT is a figure that measures the ratio between height and weight, it does not show the body proportion. FAT suits all men and women, and it is a base for people to adjust their height and weight as other healthy indexes. The ideal FAT should be between 20—25, if the figure is below 19, it means you are too thin, and if above 25 and 29, that means overweight, and if above 30, that means you are getting fat. (these data are only for references, and are not medical data.)

01	Sex	01 M	02 F
02	Age	10-----99	
03	Height	100----240	
04	Weight	20-----160	
05	FAT	≤19	Underweight
	FAT	=(20---25)	Normal weight
	FAT	=(25---29)	Overweight
	FAT	≥30	Obesity

2.1. Function of Safety Lock:

At any operating state, pull off the safety key, the treadmill stop for emergency, and all the LCD display “---” the buzzer sound “BI-BI-BI” for

alarm. The motor stops moving. When put up the lock key on the right place, the treadmill enter the standby, waiting for set up.

- (1). Check the load power before exercise; check the validity of the safety lock.
- (2). In the course of exercise with the abnormal situation, can pull of the safety lock to stop the treadmill. Re-place the safety lock to reset and wait for input command.
- (3). Non-professionals are not allowed to disassemble or repair to avoid damage to the treadmill.

3.TROUBLE SHOOTING

ERRO CODE	REASON	HOW TO SOLVE
NO DISPLAY	A) electricity not connected	Connect the electricity
	B) power switch not turn on	Turn on power switch
	C) pcb no power or broken	Press over-load protector or change new pcb
	D) signal wire not connected	Re-connect signal wire or change new one
	E) computer broken	Change new computer
	F) background light broken	Check background light wire or change new one
NOT DISPLAY ALL INFORMATIO N	A) display drive IC not inserted well	Re-insert IC,and re-weld it or change new one
	B) EMI gasket slip, not well	Re-assemble screen

1. 注意:请在使用前仔细阅读说明书,并注意以下安全事项:

- ◆ 跑步机适宜放置在室内,避免受潮,不能将水溅在跑步机上,不能放置任何异物。
- ◆ 锻炼前,请穿着合适的运动服,运动鞋。严禁光脚在跑步机上运动,并且全身舒展。
- ◆ 本产品防触电保护类为 I 类,请确认您的电源插头必须可靠接地,插座要有专用的回路,避免与其它电器设备共享。
- ◆ 儿童要远离本机,避免发生意外。
- ◆ 应该避免超长时间超负荷运行,否则会造成电机、控制器损坏、加快轴承、跑带、跑板的磨损与老化,定期做好保养。
- ◆ 减少室内灰尘,保持室内的一定湿度,避免产生强大静电,否则可能干扰电子表,控制器的正常工作。
- ◆ 运动使用完毕后请拔掉电源插座,切断电源。
- ◆ 使用跑步机时请保持室内空气流通。
- ◆ 运动时请将安全锁拉线夹夹在衣服上,以防遇到紧急情况时安全停机。
- ◆ 如果你在使用中感觉有不适应或异常情况,请停止运动,并咨询医生。
- ◆ 硅油使用后,必须储放在儿童拿不到的地方,以免误食而产生严重后果。

2. 警告:为减少事故发生或伤及他人,请遵守以下规定:

- ◆ 使用跑步机前请检查服装是否扣好或拉上拉链。
- ◆ 不要穿易被跑步机勾挂的衣服。
- ◆ 不要将电源线靠近热的物体。
- ◆ 不要让儿童接近跑步机。
- ◆ 不要在户外使用跑步机。
- ◆ 移动跑步机前必须切断电源。
- ◆ 非专业人员不得擅自拆卸本机,否则将有可能发生严重后果。
- ◆ 本跑步机只限于 20 安培以上的电路中使用,若需使用分线电源,应使用 220V/20A 以上规格的电源线,否则可能导致线路过热而发生危险。
- ◆ 机台启动时仅限一人在跑步机上运动。
- ◆ 运动时如感觉头晕、胸痛、反胃、或者呼吸急促,请立即停止运动,请您相应地咨询健身教练或医生。

3. 警告! 强制!

- ◆ 正接受医生治疗时或下述患者请务必在与专门医生商谈后方可使用。
 - (1) 现在正腰疼者或过去腿、腰、颈曾经受过伤者,腿、腰、颈和手麻木者(有椎间盘突出、脊椎滑落症、颈椎突出等宿疾者)。
 - (2) 有变形性关节炎、风湿症、痛风者。
 - (3) 有骨质疏松症等异常者。

目 录

安全说明-----	01
保修说明-----	04
产品配件-----	05
产品安装-----	08
产品使用说明-----	09
安全保养-----	16
产品简介-----	18
联系我们-----	19

真心感谢您选择 OGAWA Motion X Treadmill

使用前请阅读此说明书，特别是安全说明部分，并保留此说明予以备用

备注

本公司将保留修改设计和产品最终解释权
产品颜色以实物为准

		fastened	
NOT RUN SMOOTHLY		A) driving position has resistance	Adjust driving position, or add some silicon oil
		B) running belt too tight or too loose	Adjust the belt tension
		C) pcb torque too big or too small	Ajust torque to right position
---OR--- (OR E00/E07)		A) safety key off	Put on safety key
		B) magnetron not fixed well	Fix magnetron to right position
E01/E13		A) signal wire not well connected	Re-connect signal wire
		B) signal wire broken	Change new signal wire
		C) signal wire broken	Change new computer
		D) pcb broken	Change new pcb
E02		A) motor wire not well connected, or open circuit	Re-connect motor wire or change new motor
		B) IGBT on pcb broken	Change new pcb
		C) input voltage too low	Stop using, ask electrician to check
E03		A) speed signal wire not well connected, or sensor broken	Re-connect speed signal wire or change new sensor wire
		B) pcb broken	Change new pcb
E04		A) incline motor wire not well connected	Re-connect incline motor wire
		B) incline motor broken	Change new incline motor
		C) pcb broken	Change new pcb

E05	A) over-loaded	Turn off and re-start machine
	B) driving position hinder	Adjust driving position, or add oil
	C) motor short circuit	Change new motor
	D) pcb burnt	Change new pcb
E06	A) motor wire not well connected	Re-connect motor wire
	B) motor open circuit	Change new motor
	C) motor idling	Re-assemble to test
E08	A) storage IC not well inserted	Re-insert IC, pay attention to pins
	B) storage IC broken, or pcb broken	Change new IC, or change new pcb
E09	A) machine stand or not put evenly on floor	Put evenly on floor
	B) pcb broken	Change new pcb
E10	A) pcb torque too big	Adjust torque to right position
	B) motor short circuit	Change new motor
	C) driving position hinder	Adjust driving position, or add oil
E11	Input voltage too big	Stop using, ask electrician to check
E14	Input voltage too low	Stop using, ask electrician to check



Contact us

MALAYSIA

Healthy World Lifestyle Sdn Bnd

No.22 Jalan Anggerik Mokara 31/47

Kota Kemuning, 40460 Shah Alam Selangor Darul Ehsan, Malaysia

Tel: 1800 88 4688

Fax:+603-5121 4386

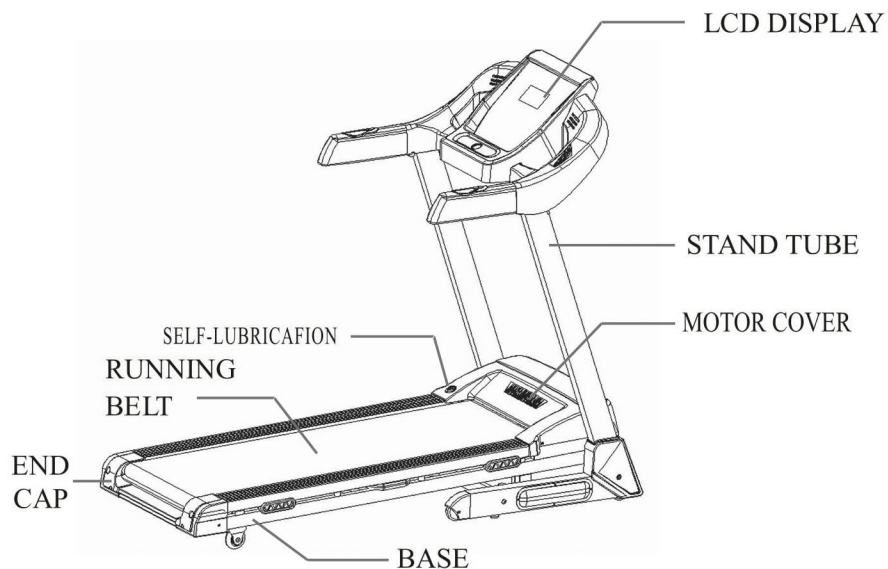

Model name.	Motion X
Model no.	OG 1420E
Voltage	AC220-240Vac, 50-60Hz
Color	Black
Function	Time, speed, distance, calorie, heart rate, Mp3 input, bluetooth,
Time range	Max 99 minutes
Max user weight	100kgs
Power	Max 2.0 HP

1. Lubrication

After running for a period of time, the treadmill must be configured with special cymene silicone oil for lubrication.

Suggestion:

Use less than 3 hours each week	Lubricate once every 5 months
Use 4-7 hours each week	Lubricate once every 2 months
Use more than 8 hours each week	Lubricate once every 1 month

Do not lubricate more than what you need to. Remember: regular and reasonable lubrication is to improve the lifespan of your treadmill.

2. Running belt tension adjustment

You may need to adjust the treadmill according to your personal needs. But after running for a period of time, due to personal weight, the belt tension may change from default setup. If you realize that the belt is slippery that may be caused by loose tension, then you need to adjust the running belt and roller. Please do not adjust too tight that may bring too much pressure on the motor which would damage the motor, running belt and roller.

3. Running belt far to the right side adjustment

At the operating state, pressing the “+” and “-” or the rise “**SHORTCUT**” key can adjust the grade of the treadmill.

- ① Main frame is not being placed on a flat surface.
- ② Users are not running in the middle of the belt.
- ③ Forced deviation. After a few minutes no-load rotation, the deviation can not be automatically restored. If not recovered, you may adjust it with the 6mm hex key in the Tool Kit, turn it clockwise for 90 degrees. Please see the figure below.

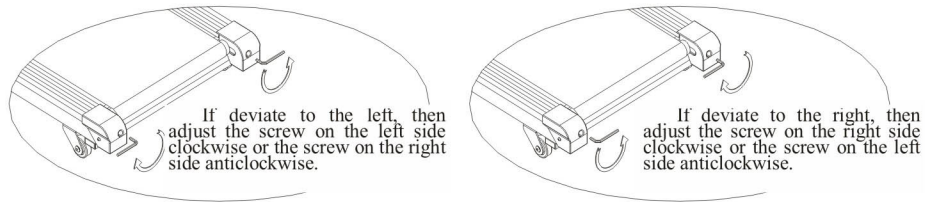

If deviate to the left, then adjust the screw on the left side clockwise or the screw on the right side anticlockwise.

If deviate to the right, then adjust the screw on the right side clockwise or the screw on the left side anticlockwise.

The running belt deviation is not covered by the manufacture warranty. It is the owner's responsibility to maintain and adjust according to the users' manual. Once you observe the running belt going to one side, you would need to adjust it in order to avoid serious damage to the running belt.

4. The adjustment to the Driven belt

If the driven belt becomes loose after using for a period of time, you need to:

Use the wrench to turn the adjusting bolt clockwise until the driven belt is not slippery anymore.

Note: Regular clean any objects that fell between The driven belt. This is a mandatory process.



Adjusting blot